

# Pocket NC V2 User's Manual

March 2019

English

Original Instructions



© 2019 Pocket NC Company

All rights reserved. No part of this publication may be reproduced, stored in a retrieval system, or transmitted, in any form, or by any means, mechanical, electronic, photocopying, recording, or otherwise, without the written permission of Pocket NC Company. No patent liability is assumed with respect to the use of the information contained herein. Moreover, because Pocket NC Company strives constantly to improve its high-quality products, the information contained in this manual is subject to change without notice. We have taken every precaution in the preparation of this manual; nevertheless, Pocket NC Company assumes no responsibility for errors or omissions, and we assume no liability for damages resulting from the use of the information contained in this publication.







## Revision History

First Release: October 2017 (JD)

Version 2: March 2019 (QR)

## Limited Warranty Certificate

Please read the following carefully. It affects your rights as a purchaser of this product.

Pocket NC Company's warranty obligations and liability for all hardware products sold by Pocket NC Company in the fifty United States, the District of Columbia, and U.S. Territories are limited exclusively to the terms set forth below (this "Warranty").

Pocket NC Company warrants our hardware products against defects in materials and workmanship under normal use for a period of one year from the date of delivery to the original purchaser (the "Warranty Period").

If a hardware defect arises, and a valid claim is received within the Warranty Period, at our sole option and to the extent permitted by law, POCKET NC COMPANY will either: (1) Repair the hardware defect at no charge, using new or refurbished replacement parts; (2) Exchange the product with a product that is new or reconditioned by POCKET NC COMPANY or that has been manufactured from new or serviceable used parts and is functionally equivalent to the original product; (3) Refund the purchase price of the product.

A repaired or replacement product assumes the remaining warranty of the original product or 6-months (180 days) from the date of replacement or repair, whichever is longer.

When a product is exchanged, any replacement item becomes your property and the replaced item becomes POCKET NC COMPANY property. In order to receive a refund, the product for which the refund is provided must be returned to POCKET NC COMPANY and becomes the property of POCKET NC COMPANY.

## Exclusions from and Limitations to Warranty

This Warranty applies only to hardware products manufactured by or for POCKET NC COMPANY. The Warranty does not apply to any non-POCKET NC COMPANY hardware products or any software, even if packaged or sold with POCKET NC COMPANY hardware. Manufacturers, suppliers, or publishers other than POCKET NC COMPANY may provide their own warranties to the end user purchaser. Software distributed by POCKET NC COMPANY with or without the POCKET NC COMPANY brand name (including, but not limited to system





software) is not covered under this Limited Warranty. Refer to the Terms and Conditions for the software for details of your rights with respect to its use.

POCKET NC COMPANY does not warrant that the operation of the product will be uninterrupted or error-free. POCKET NC COMPANY is not responsible for personal injury or property damage arising or resulting from failure to follow instructions relating to the product's use, storage, or handling.

This Warranty does not apply to: (1) Damage caused by accident, abuse, misuse, neglect, flood, fire, earthquake, or other external causes; (2) Damage caused by operating the product outside the permitted or intended uses described by POCKET NC COMPANY; (3) Damage to a product or part caused by or resulting from a modification to alter its functionality or capability without the written permission of POCKET NC COMPANY; (4) Cosmetic damage, including but not limited to scratches, dents, and ordinary wear and tear.

This Warranty gives you specific legal rights, and you may also have other rights which vary from state to state. POCKET NC COMPANY's responsibility for hardware defects is limited to the repair or replacement service, or to refund, as described in this Warranty and determined by POCKET NC COMPANY in its sole discretion.

### Disclaimer of Warranties; limitation of liability

Except as explicitly provided in this Warranty, we do not guarantee, represent, or warrant that your use of our service or any POCKET NC COMPANY product will be uninterrupted, timely, secure, or error-free. We do not warrant that the results that may be obtained from the use of the service or the product will be accurate or reliable.

The products delivered to you by POCKET NC COMPANY are (except to the extent otherwise expressly stated by us in this Warranty) provided "AS IS" and "AS AVAILABLE" for your use, and, except as expressly set forth in this Warranty, without any representation, warranties, or conditions of any kind, either express or implied. POCKET NC COMPANY further disclaims all implied warranties or conditions of merchantability, merchantable quality, fitness for a particular purpose, durability, title, and non-infringement.

Some states restrict or do not allow limitations on warranties, which may affect your rights, and this Limited Warranty will be adjusted to maintain compliance with such state limitations or restrictions.

No POCKET NC COMPANY reseller, agent, or employee is authorized to make any modification, extension, or addition to this Warranty and the terms in this Warranty shall constitute the entire agreement between you and POCKET NC COMPANY concerning the matters discussed herein. If any term is held to be illegal or unenforceable by a court of competent jurisdiction, the legality or enforceability of the remaining terms shall not be affected or impaired and shall remain in full force and effect.



Except as provided in this Warranty and to the extent permitted by law, POCKET NC COMPANY is not responsible for direct, indirect, special, incidental, or consequential damages resulting from any breach of warranty or condition or any other reason, or under any other legal theory, including but not limited to loss of use; loss of revenue; loss of actual or anticipated profits (including loss of profits on contracts); loss of the use of money; loss of anticipated savings; loss of business; loss of opportunity; loss of goodwill; loss of reputation; loss of, damage to, or corruption of data; or any indirect or consequential loss or damage howsoever caused, including the replacement of equipment and property, any costs of recovering, programming, or reproducing any program or data stored or used with POCKET NC COMPANY products and any failure to maintain the confidentiality of data stored on the product. This is true even if POCKET NC COMPANY is advised of the possibility of such damages.

POCKET NC COMPANY's liability for actual damage from any cause whatsoever will be limited to the greater of 1) \$2,000 or 2) the amount you paid for the product that caused the damage. This limitation of liability will not apply to claims for bodily injury, or damage to real property or tangible personal property for which POCKET NC COMPANY is legally liable. In no event will either party be liable for any damage caused by the other party's failure to fulfill its responsibilities under this Limited Warranty.

Some states do not allow for the foregoing damages cap and exclusion or limitation of incidental or consequential damages, so the above limitations may not apply to you.

## Obtaining Warranty Service

Please access and review the online help resources referred to in the documentation accompanying this hardware product before requesting warranty service. If the product is still not functioning properly after making use of these resources, please contact POCKET NC COMPANY at [info@pocketnc.com](mailto:info@pocketnc.com).

Help us help you. You must provide reasonable assistance to POCKET NC COMPANY in diagnosing issues with your product and follow POCKET NC COMPANY's warranty processes.

POCKET NC COMPANY restricts service to the United States of America and the District of Columbia and U.S. territories. For qualifying warranty service, POCKET NC COMPANY will send a prepaid shipping label to enable you to ship the product in its original packaging to POCKET NC COMPANY's repair service location for service. If the original packaging is not kept, you will be charged for a replacement POCKET NC COMPANY product packaging box to be sent to you to enable you to ship the product to POCKET NC COMPANY's repair service location. Upon your receipt of the replacement product, the original product becomes the property of POCKET NC COMPANY and you agree to follow instructions, including, if required, arranging the return of original product to POCKET NC COMPANY in a timely manner.

Service options, parts availability, and response times may vary. In accordance with applicable law, POCKET NC COMPANY may require that you furnish proof of purchase details and/or



comply with registration requirements before receiving warranty service. Please refer to the according documentation for more details on this and other matters on obtaining warranty service.

POCKET NC COMPANY will maintain & use customer information in accordance with the POCKET NC COMPANY Privacy Policy. The contents of your product will be deleted and the storage media reformatted in the course of warranty service. Your product will be returned to you configured as originally purchased, subject to applicable updates.



## Customer Feedback

If you have concerns or questions regarding this Operator's Manual, please contact us on our website, [www.pocketnc.com](http://www.pocketnc.com). Use the "Contact Us" link and send your comments to the Customer Advocate.

You also can find an electronic copy of this manual and other useful information on our website under the "Help" tab.

Join Pocket NC owners online and be a part of the greater CNC community at these sites:



Google Groups: <https://groups.google.com/forum/#!forum/pocket-nc>



Facebook: <https://www.facebook.com/pocketnc>



Twitter: <https://twitter.com/pocketnc>



Instagram: [https://www.instagram.com/pocket\\_nc/](https://www.instagram.com/pocket_nc/)



YouTube: <https://www.youtube.com/c/pocketnc>



## Declaration of Conformity

Product: 5 Axis Desktop CNC Mills

Physical:

Pocket NC  
119A Gold Miner Lane  
Belgrade, MT 59714

Mailing:

Pocket NC  
1051 Springbrook Avenue  
Bozeman, MT 59718

We, Pocket NC Company, hereby declare that the following products,

Pocket NC V2-10 and V2-50, 5 axis desktop CNC mills

fulfill all of the relevant requirements of

- EC Machinery Directive 2006/42/EC
- EC EMF Directive 2014/30/EU
- EC Low Voltage Directive 2006/95/EC







## How to Use this Manual

To get the maximum benefit of your new Pocket NC machine, read this manual thoroughly and refer to it often. The content of this manual is also available online at [www.pocketnc.com](http://www.pocketnc.com).

**IMPORTANT:** Before you operate the machine, read and understand the Operator's Manual Safety chapter.

### Declaration of Warnings

Throughout this manual, important statements are set off from the main text with an icon and an associated signal word: "Danger," "Warning," "Caution," or "Note." The icon and signal word indicate the severity of the condition or situation. Be sure to read these statements and take special care to follow the instructions.

Description	Example
Danger means that there is a condition or situation that will cause death or severe injury if you do not follow the instructions given.	 <b>DANGER:</b> Risk of electrocution. Do not open cabinet.
Warning means that there is a condition or situation that will cause moderate injury if you do not follow the instructions given.	 <b>WARNING:</b> Never put your hands between the tool and the workpiece while in operation.
Caution means that minor injury or machine damage could occur if you do not follow the instructions given. You may also have to start a procedure over if you do not follow the instructions in a caution statement.	 <b>CAUTION:</b> Power down the machine before you do maintenance tasks.
Note means that the text gives additional information, clarification, or helpful hints.	 <b>NOTE:</b> Follow these guidelines to set the tool length offset.



## Text Conventions Used in this Manual

Description	Text Example
Code Block text gives program examples.	G00 G90 G54 X0. Y0.;
A Control Button Reference gives the name of a control key or button that you are to press.	Press <b>[CYCLE START]</b> .
A File Path describes a sequence of file system directories.	<i>Service &gt; Documents and Software &gt;...</i>
A Mode Reference describes a machine mode.	MDI
System Output describes text that the machine control displays in response to your actions.	PROGRAM END
User Input describes text that you should enter into the machine control.	G04 P1.;



## Table of Contents

<b>Revision History</b>	<b>4</b>
<b>Limited Warranty Certificate</b>	<b>4</b>
Exclusions from and Limitations to Warranty	4
Disclaimer of Warranties; limitation of liability	5
Obtaining Warranty Service	6
Customer Feedback	8
<b>Declaration of Conformity</b>	<b>9</b>
<b>How to Use this Manual</b>	<b>10</b>
Declaration of Warnings	10
Text Conventions Used in this Manual	11
<b>Chapter 1: Safety</b>	<b>17</b>
Chapter 1.1: Introduction	17
Chapter 1.1.1: Read Before Operating	17
Chapter 1.2: Unattended Operation	19
Chapter 1.3: Modifications to the Machine	19
Chapter 1.4: Safety Decals	19
Chapter 1.5: Mill Warning Decal	20
Chapter 1.6: More Information Online	20
<b>Chapter 2: User Interface and Basic Operations</b>	<b>22</b>
Chapter 2.1: Mill Orientation	22
Chapter 2.2: Software Setup	23
Chapter 2.3: Startup and Shutdown	23
Chapter 2.3.1: Startup	23
Chapter 2.3.2: Shutdown	26
Chapter 2.4: Production	26
	12





Chapter 2.4.1: Homing	26
Chapter 2.4.2: Jogging	27
Chapter 2.4.2.1: Step-Size	29
Chapter 2.4.3: DRO Interface	29
Chapter 2.4.4: Loading a Program	30
Chapter 2.4.5: Running a Program	31
Chapter 2.4.5.1: Spindle Rate and Feed Rate Control	32
Chapter 2.4.5.2: Optional Stop	33
Chapter 2.5: MDI Interface	33
Chapter 2.6: Tooling/Tool Table:	34
Chapter 2.6.1: Tool Table	35
Chapter 2.6.2: Tool Measurement	35
Chapter 2.7: Configurations	36
Chapter 2.7.1: Network	36
Chapter 2.7.2: Display/Changing Unit System	37
Chapter 2.7.3: Jogging	38
Chapter 2.7.4: Server	38
Chapter 2.7.5: Status	40
Chapter 2.7.6 Version	41
<b>Chapter 3: Machine Operation</b>	<b>41</b>
Chapter 3.1: File Management	41
Chapter 3.2: Loading Files	42
Chapter 3.3: Running a Program	43
Chapter 3.4: Deleting a File	44
Chapter 3.5: V2-10 and V2-50 Tooling	44
Chapter 3.5.1: V2-10 Tool Holders	44



Chapter 3.5.2: Tool Holder Care	45
Chapter 3.5.3: Tool Setup and Holder Setup	46
Chapter 3.5.4: Tool Setup	46
Chapter 3.5.5: Tool Change	47
Chapter 3.5.5.1: Tool Holder Change	47
Chapter 3.5.5.2: Tool Change	47
Chapter 3.5.5.3: V2-50 Tool Change	47
Chapter 3.5.6: Using the Tool Probe	48
Chapter 3.5.7: Measuring the Tool Length Offset by Hand	51
Chapter 3.5.7.1: Tool Offset Setup Procedure	52
Chapter 3.6: Feeds and Speeds	54
Chapter 3.7: Part Setup	59
Chapter 3.7.1: Pocket NC Vise	59
Chapter 3.7.1.1: How to Use the Pocket NC Vise	60
Chapter 3.7.1.2: Installing the Pocket NC Vise	61
Chapter 3.7.2: ER-40 Collet System	66
Chapter 3.7.2.1 Installing the Collet System	67
Step One: Install the Bottom Tapered Nut	67
Step Two: Install the Collet	68
Step Three: Install the Top Tapered Nut and the Stock.	68
Chapter 3.7.3 Sacrificial Plate	69
<b>Chapter 4: G and M Codes</b>	<b>71</b>
<b>Chapter 5: Maintenance, Storage, and Transport</b>	<b>73</b>
Chapter 5.1 Maintenance	73
Chapter 5.2: Storage	73
Chapter 5.3: Transport	73



<b>Chapter 6: Troubleshooting Common Problems</b>	<b>74</b>
Chapter 6.1: Common Problems	75
Chapter 6.2: Machining/Performance Issues	78
Chapter 6.3: Error Codes	81





## Chapter 1: Safety

### Chapter 1.1: Introduction



**CAUTION:** Only authorized and trained personnel may operate this equipment. You must always act in accordance with the Operator's manual, safety decals, safety procedures and instructions for safe machine operation. Untrained personnel present a hazard to themselves and the machine.

**IMPORTANT:** Read and understand all warnings, cautions, and instructions before operating this machine. All milling machines present hazards from rotating cutting tools, belts and pulleys, high voltage electricity, and noise. When you use CNC machines and their components, you must always follow basic safety precautions to reduce the risk of personal injury and mechanical damage.

#### Chapter 1.1.1: Read Before Operating



**DANGER:** Do not enter the machining area any time the machine is in motion.

Severe injury or death may result.

Basic safety:

- Consult your local safety codes and regulations before operating the machine. Contact Pocket NC any time safety issues need to be addressed.
- It is the machine owner's responsibility to make sure that everyone who is involved in installing and operating the machine is thoroughly acquainted with the operation and safety instructions provided with the machine **BEFORE** they perform any actual work. The ultimate responsibility for safety rests with the machine owner and the individuals who work with the machine.
- Use appropriate eye protection while operating the machine. ANSI-approved impact safety goggles are recommended to reduce the risks of eye damage.
- This machine is automatically controlled and may start at any time.
- This machine can cause severe bodily injury.



- As sold, your machine is not equipped to process toxic or flammable material; this can create deadly fumes or suspended particles in the air. Consult with the material manufacturer for safe handling of material by-products, and implement all precautions before you work with such materials.
- When moving machine, always lift by the base and the L bracket. Never lift by movable components.

#### Electrical safety:

- The electrical power must meet the required specifications. Attempting to run the machine from any other source can cause severe damage and will void the warranty.
- The electrical panel covers should be in place and fastened to the machine at all times, except when the machine is being serviced. When the machine is on, there is high voltage throughout the electrical cabinet (including the circuit boards and logic circuits) and some components operate at high temperatures; therefore, extreme caution is required.
- Never service the machine with the power connected.

#### Operation Safety:

- Do not operate the machine unless all body parts and clothing are clear of the work area. Rotating cutting tools can cause severe injury. When a program runs, the mill table and spindle head can move rapidly at any time, and in any direction.
- [POWER] is the black switch located on the front of the machine. When you switch [POWER], the axis motors, spindle motor, and gear motors all stop. While [POWER] is in the off position, both automatic and manual motion is disabled. Use [POWER] in case of emergency.
- Check for damaged parts and tools before operating the machine. Any part or tool that is damaged should be properly repaired or replaced by authorized personnel. Do not operate the machine if any component does not appear to be functioning correctly.
- Keep your hands away from the tool in the spindle when the machine is in operation.



**DANGER:** Improperly clamped parts or oversized parts may be ejected with force.

Follow these guidelines while you work with the machine:



- Normal operation – Keep clear of the work area of the machine while the machine operates.
- Part loading and unloading – An operator ensures the machine is not in operation, completes a task, clears the work area of the machine, then presses [START/PAUSE] (the green button on the machine which starts automatic motion).
- Tool loading and unloading – A machinist enters the machining area to load or unload tools. Exit the area completely before automatic movement is commanded (for example, [PAUSE]).
- Maintenance / Machine Cleaner – Switch [POWER] to off position.
- Do not operate the machine with the table loaded with over 1.5 pounds of material.
- If using material larger than the work volume of the machine, ensure that the movements in the program will not cause a crash.

## Chapter 1.2: Unattended Operation

The Pocket NC is not designed for unattended operation.

As it is the machine owner's responsibility to set up the machine safely and use best practice machining techniques, it is also their responsibility to manage the progress of these methods. The machining process must be monitored to prevent damage if a hazardous condition occurs.

For example, if there is the risk of fire due to the material machined, then you must install an appropriate fire suppression system to reduce the risk of harm to personnel, equipment and the building.

## Chapter 1.3: Modifications to the Machine

DO NOT modify or alter this equipment in any way. Pocket NC must handle all modification requests. Modification or alteration of any Pocket NC machine without authorization could lead to personal injury and mechanical damage, and will void your warranty.

DO NOT use liquid coolant on this machine. The electronics are not waterproof and liquids are likely to create a short circuit.

## Chapter 1.4: Safety Decals

To help ensure that CNC machine dangers are quickly communicated and understood, hazard symbol decals are placed on Pocket NC machines in locations where hazards exist. If decals become damaged or worn, or if additional decals are needed to emphasize a particular safety point, contact Pocket NC.



Note: Never alter or remove any safety decal or symbol.

Each hazard is defined and explained on the general safety decal, located at the side of the machine. Review and understand each safety warning and familiarize yourself with the symbols before operation.

### Chapter 1.5: Mill Warning Decal

This is an example of a general mill warning decal in English.



Figure 1 Mill Warning Decal Example

### Chapter 1.6: More Information Online





For updated and supplemental information, including tips, tricks, maintenance procedures, and more, go to [www.PocketNC.com](http://www.PocketNC.com) and select the Help>Resources.



## Chapter 2: User Interface and Basic Operations

The purpose of this chapter is to introduce users to the new Pocket NC user interface. The topics covered in this chapter are interface navigation, machine controls, loading and running programs, editing the tool table, conducting tool length measurements using the tool probe feature, and changing the display units.

### Chapter 2.1: Mill Orientation

The following figures show some of the standard and optional features of your Pocket NC. Note that these figures are representative only; your machine's appearance may vary depending on the model and installed options.

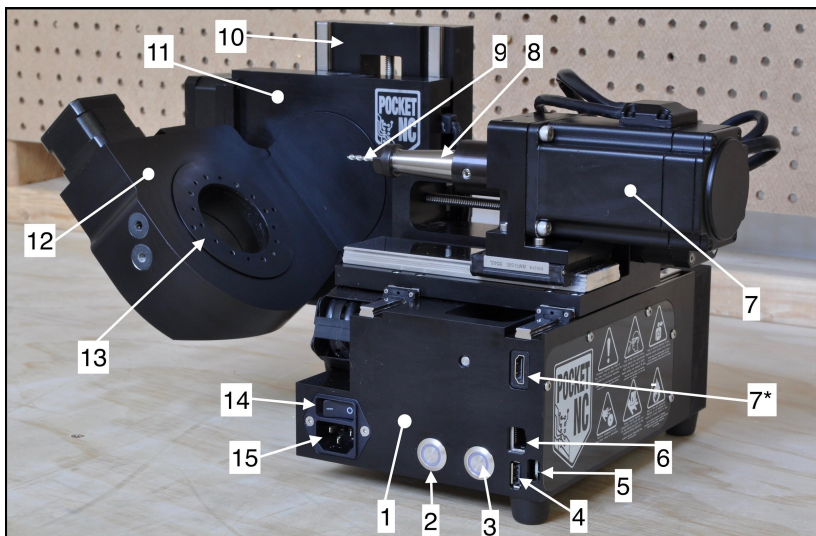

- |   |   |
|---|---|
| 1. Main Block                             | 8. Tool Holder                                |
| 2. E-Stop Button                          | 9. Tool                                       |
| 3. Pause/Cycle Start Button               | 10. L-Bracket                                 |
| 4. USB Port                               | 11. A-housing (part of the Trunnion assembly) |
| 5. Mini USB Port                          | 12. B-housing (part of the Trunnion assembly) |
| 6. Ethernet Port                          | 13. B-table (part of the Trunnion assembly)   |
| 7. Spindle                                | 14. Power Switch                              |
| 7* HDMI Port (not on production machines) | 15. Power Plug                                |



## Chapter 2.2: Software Setup

Software needed: web browser (Chrome, Firefox, Safari) No internet connection is required

Hardware needed: computer/Chromebook, USB to mini USB cable

## Chapter 2.3: Startup and Shutdown

Applicable drivers should be installed for machines and you should simply have to connect as described below, although there are some specifics if you are running Mac OSX - Big Sur or Catalina. If you have any issues or are running one of these Mac systems please read [here](#). If you would prefer to connect via the network please reach [here](#).

Download and install one of the following web browsers:

- Google Chrome
- Firefox
- Safari

### Chapter 2.3.1: Startup

- Turn on your machine.
- Connect to your computer using the mini USB port.
- Wait about 30 seconds for the machine to fully boot before attempting to connect to it.  
The red, E-stop button will blink when the machine is fully booted.
- Open your web browser and type the Pocket NC's IP address, "192.168.7.2" into the search bar.

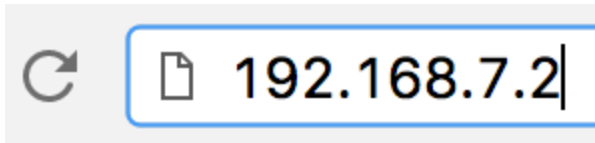

- The User Interface will open in the “Production” screen.

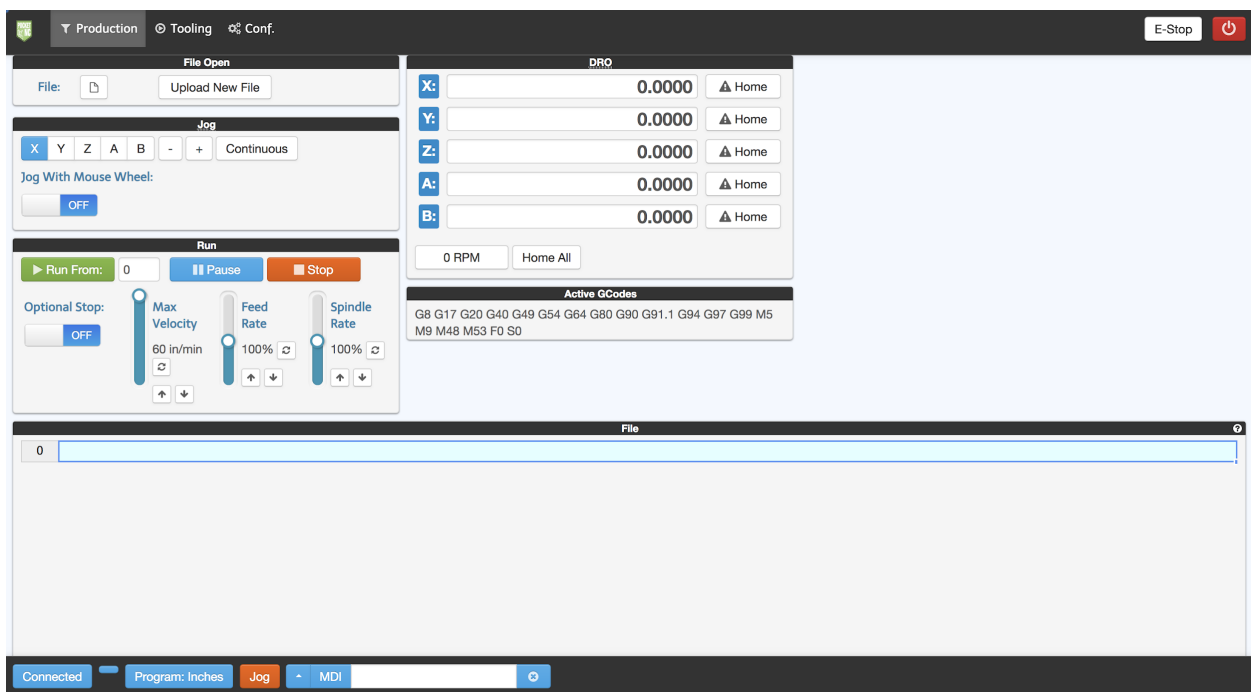

- By default the power to the axes will be off, in order to enable the axes click on the “E-Stop” button in the upper right corner of the screen. You will note that the E-stop (red button) on the Pocket NC mill will blink until the motor power is enabled and will be solid after the motors are active. The E-Stop button turns to red to indicate it’s on.

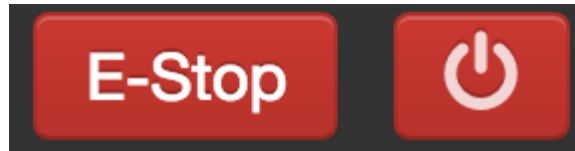
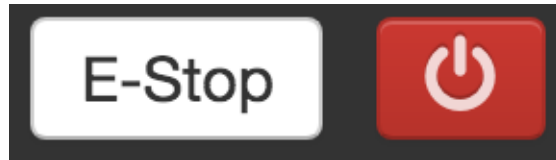

- Before running any programs the machine must be homed. Click the “Home All” button in order to send all axes to their home positions. The screenshot below shows the coordinates of the machine’s home position.

**DRO**

<b>X:</b>	2.5000	Home
<b>Y:</b>	2.5000	Home
<b>Z:</b>	0.0000	Home
<b>A:</b>	-0.0000	Home
<b>B:</b>	0.0000	Home

0 RPM   **Home All**   Click here to send all axes to their home positions



## Chapter 2.3.2: Shutdown

- When you are done operating the machine, click the Power button in the upper right corner of the screen, then select “shutdown” to shutdown the machine. Shut off the power button on the Pocket NC and unplug the machine from the computer.
- The computer may generate an error message warning you to eject the BeagleBone before unplugging it. You may eject the BeagleBone from the computer if desired, but it is not necessary.

## Chapter 2.4: Production

The new interface opens in the production screen.

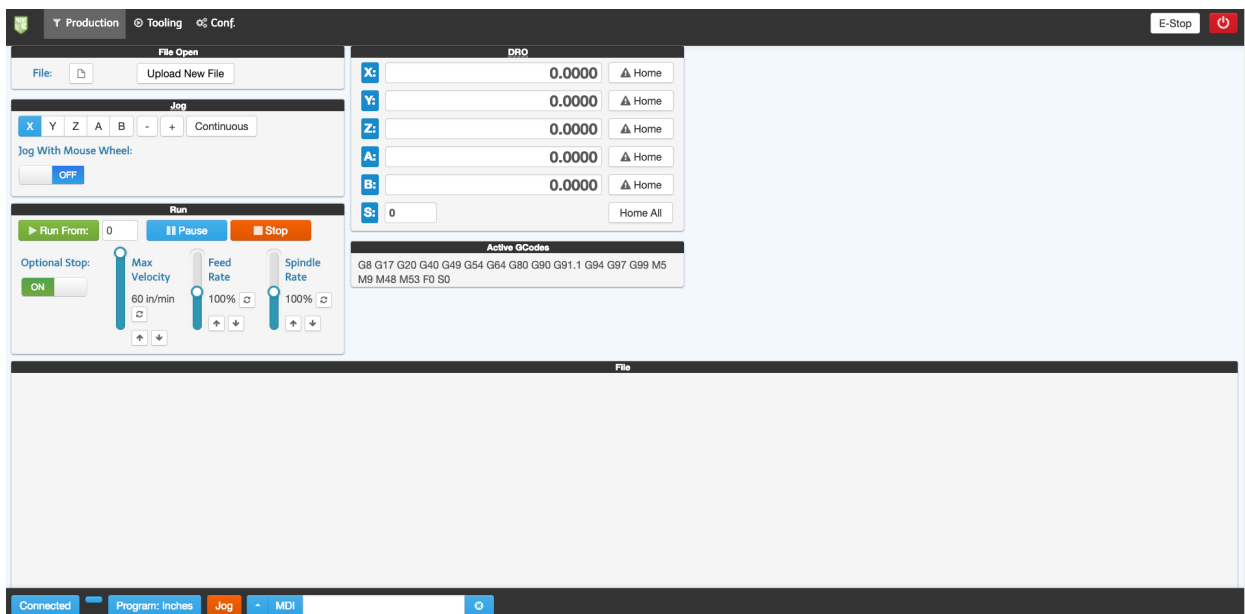

The power to the Pocket NC motors is off by default when the machine boots. Enable the power to the motors by clicking on the “E-stop” button. The Power and “E-stop” buttons will change from white to red when the motors are active.

### Chapter 2.4.1: Homing

All the axes on the a machine must be homed before executing any MDI commands or running any programs. Click the “Home All” button in order to send all axes to their home positions.

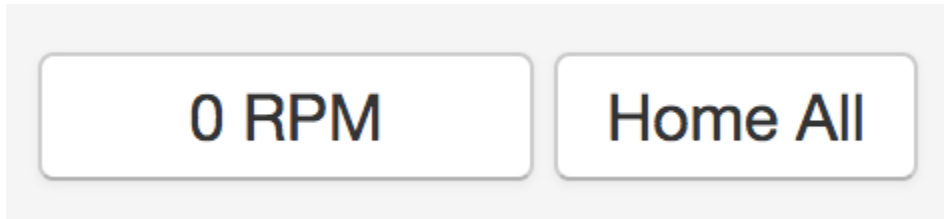

After the axes are homed the Digital Readout (DRO) will look like the image below.

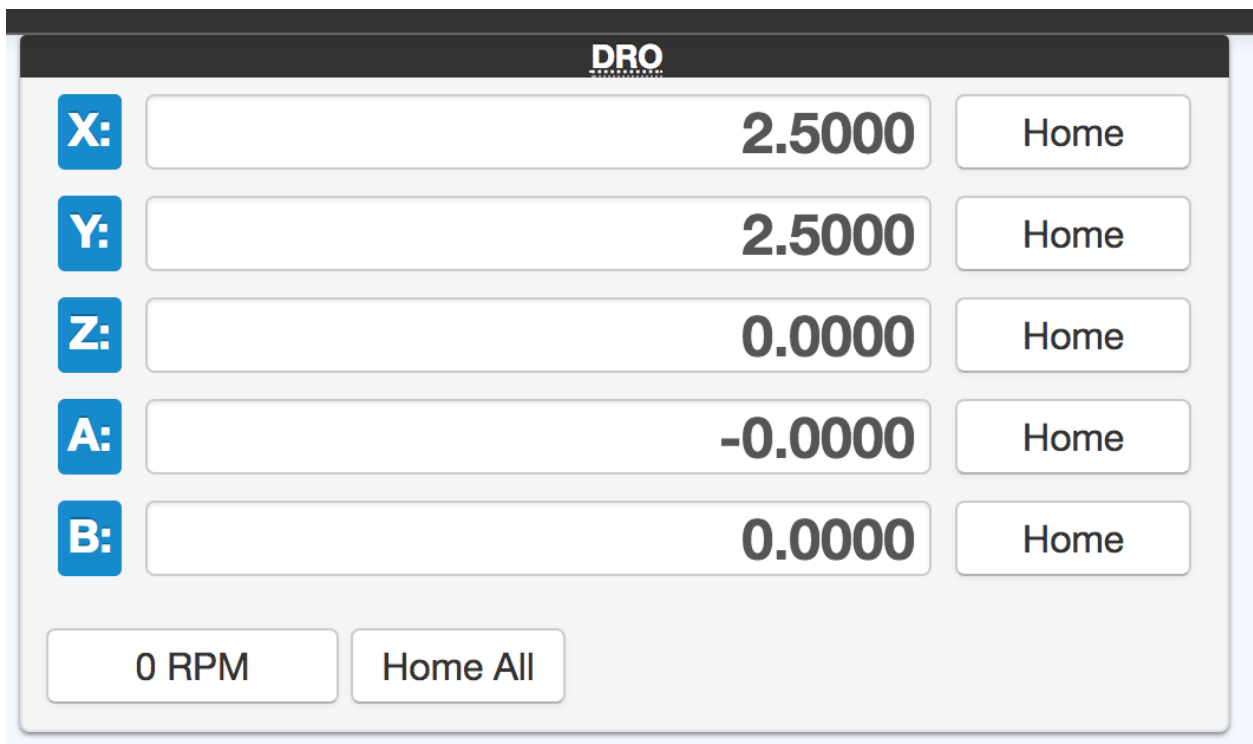

### Chapter 2.4.2: Jogging

There are a number of ways that the user can control the machine axes. The user can select the axis he would like to move by clicking on the axis buttons. The user can then jog that button using the plus (+) and minus (-) buttons.

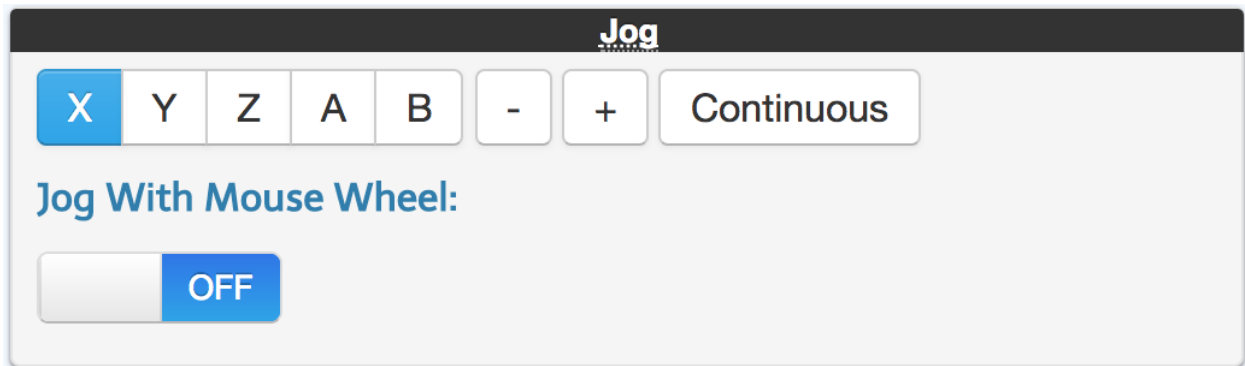

The user can also jog the axes using the mouse wheel by turning enabling the “Jog With Mouse Wheel” button and selecting the desired axis of motion by clicking on the respective button.

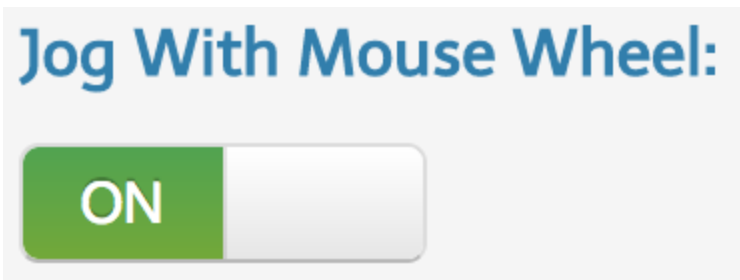
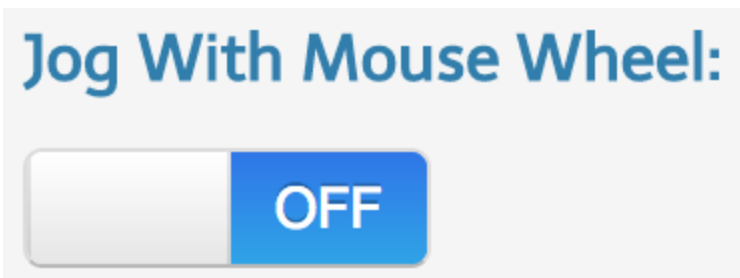

Finally, the user may also use keyboard controls to move the axes. The arrow keys control the X and Y axes, the “Z” and “X” keys are used to control the Z axis, the “A” and “S” keys control the A axis, finally, the “B” and “N” keys are used to control the B axis. The settings for the keyboard controlled jogging are located in the “Jog” menu at the bottom of the page. Click on the “Jog” button to bring up a list of the available step sizes. The available step sizes can be adjusted in the machine configurations.



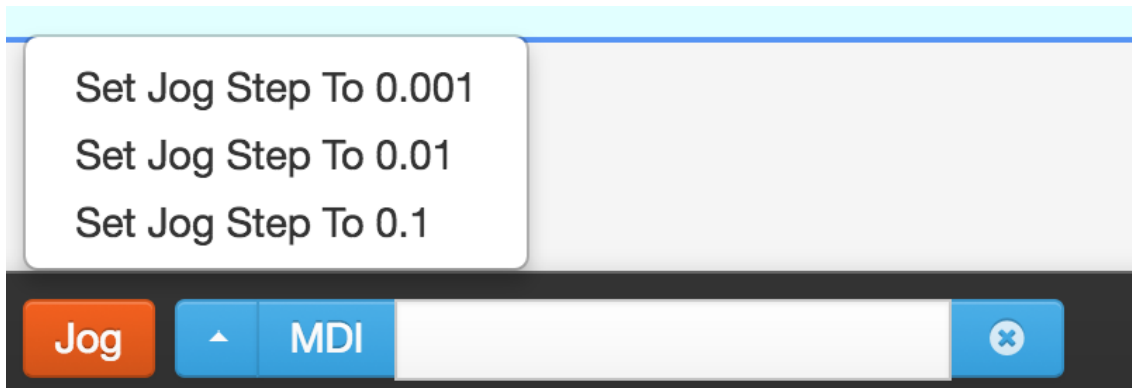

### Chapter 2.4.2.1: Step-Size

The step-size can be changed by clicking on the step size readout and choosing the desired step-size from the dropdown list. Note that the rotary axes have different step-size options than the linear axes. The step-size units are inches, centimeters, or millimeters for the linear axes and degrees for the linear axes. The user can change the units of the linear axes in the “Configurations” tab. The units in the images below are inches.

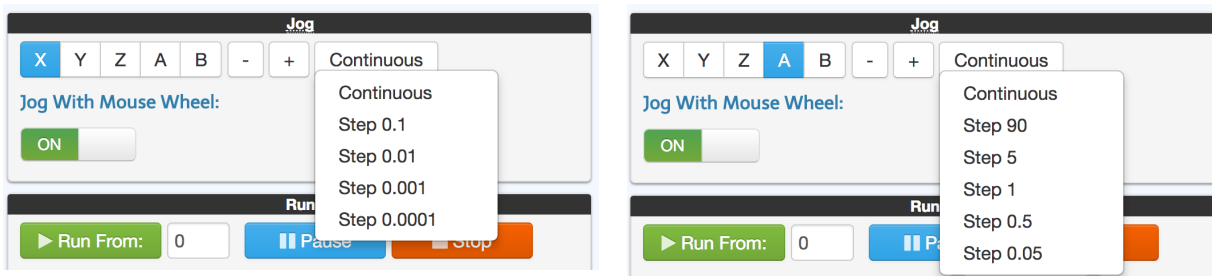

### Chapter 2.4.3: DRO Interface

The digital readout (DRO) allows the user to see the position of each of the machine axes. The user may also use the DRO to home axes individually.

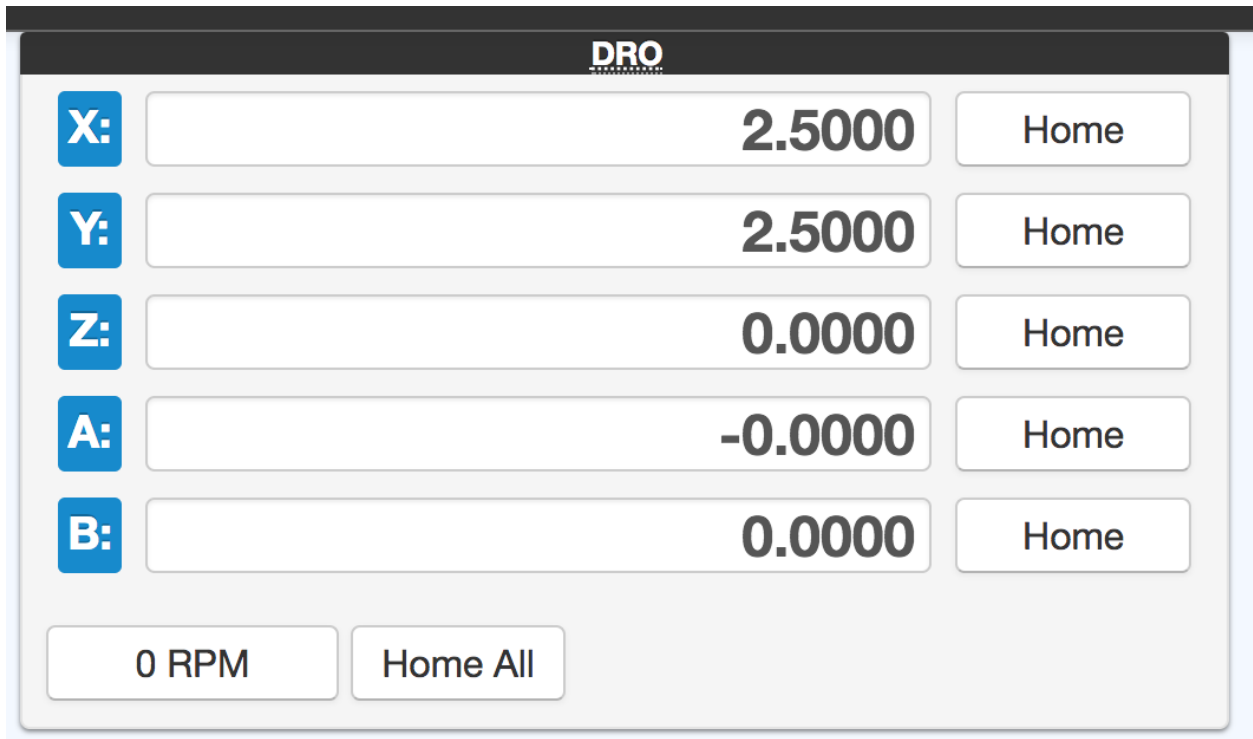

#### Chapter 2.4.4: Loading a Program

Upload a machining file to the BeagleBone by clicking on the "Upload New File" button.

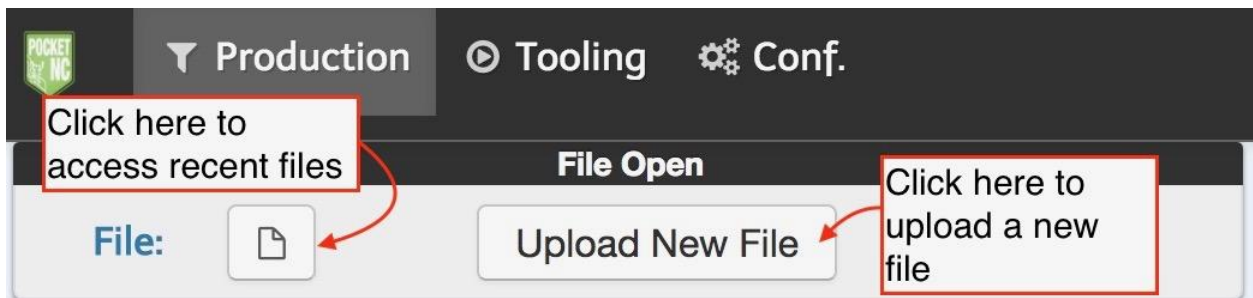

Select your .ngc file from the file directory on your computer or USB flash drive.

After the file has been successfully uploaded, the file name will appear in the file window on the left side of the screen as well as in the file display window at the bottom of the screen.

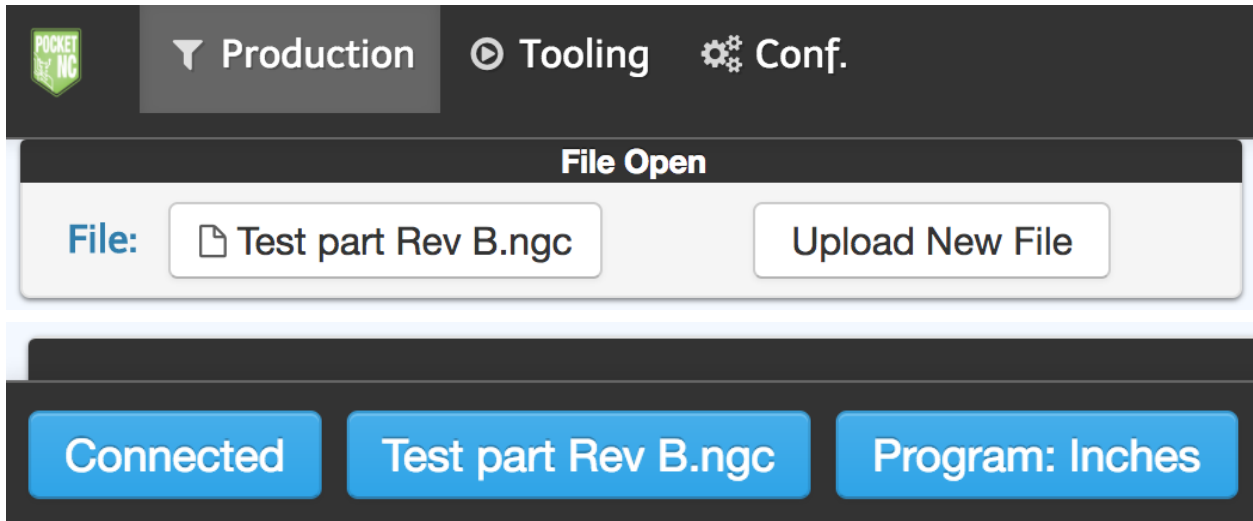

Once the file is loaded, the code will be displayed in the “File” display area at the bottom of the screen. The user can view the file before running it and while it runs using this interface.

File	
0	%
1	( <i>AXIS,stop</i> )
2	(1)
3	<i>N10 G20</i>
4	<i>N15 G90 G94 G40 G17 G91.1</i>
5	<i>N20 G53 G0 Z0.</i>
6	( <i>CONTOUR1 2</i> )
7	<i>N25 M9</i>
8	<i>N30 G49</i>

#### Chapter 2.4.5: Running a Program

Run the program by clicking the green “Run From” button.

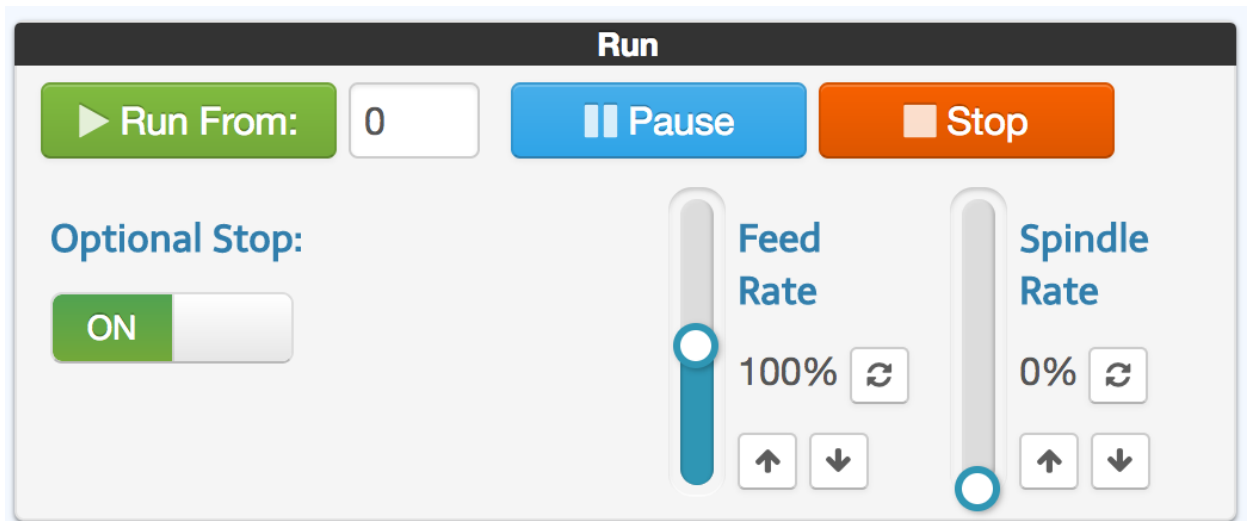

If you have an M0 (or M1 with optional stop on) command at the start of your code, the program will be paused. Click the blue “Pause/Resume” button or push the green “Pause/Go” button on the machine in order to start the program. The user may pause the program at any point by clicking the “Pause” button or pushing the green button on the machine. The user can stop the program by clicking the “Stop” button or pushing the red, emergency stop button on the machine.



#### Chapter 2.4.5.1: Spindle Rate and Feed Rate Control

The user can change the feed rate and spindle speed while the program is running by toggling the Spindle Rate and Feed Rate controls. The arrows adjust the speed in 5% increments. The reset button resets the value of the spindle or feed rate to 100% of the program value.

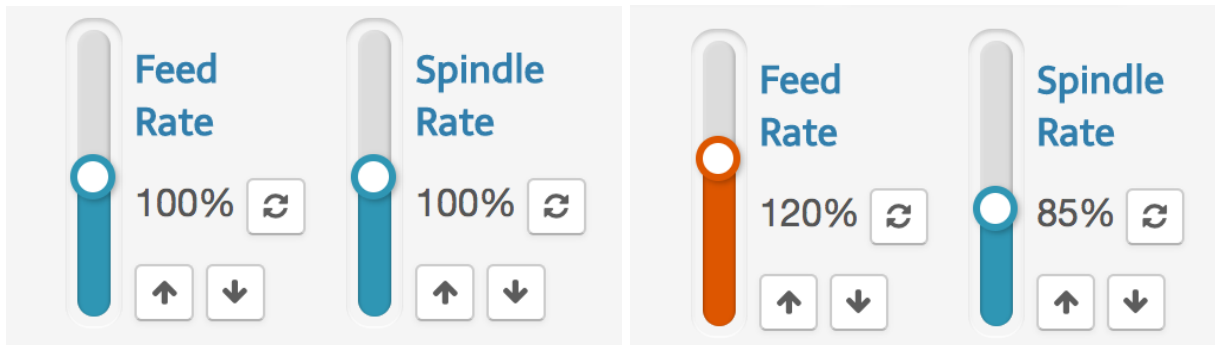

#### Chapter 2.4.5.2: Optional Stop

The user can choose whether or not to have the program stop for optional stops in the program by toggling the optional stop button on or off. This allows the user to include optional stops for part checks and turn them off once the program is proved.

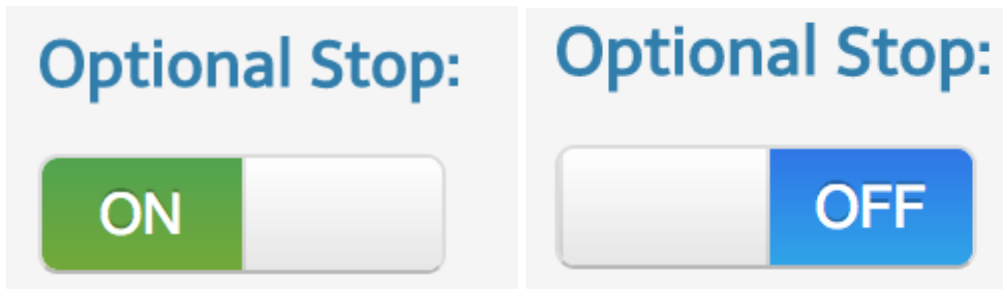

#### Chapter 2.5: MDI Interface

The MDI interface allows the user to give the Pocket NC commands directly by typing in lines of G-code.



Recently used codes can be accessed by clicking on the arrow to the left of the MDI window.

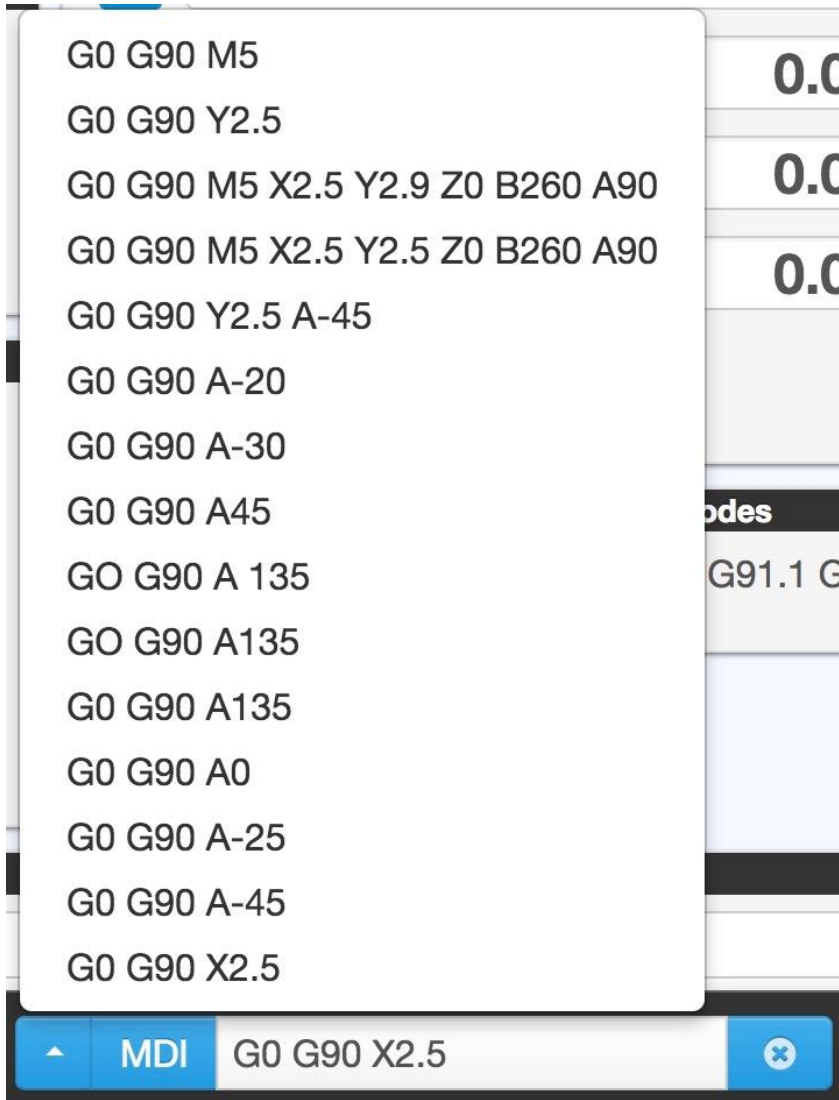

### Chapter 2.6: Tooling/Tool Table:

The Tooling tab contains the tool table, work offset table, and a second digital readout screen.



## Chapter 2.6.1: Tool Table

Tool Table				
	Z Offset	Diameter	Description	
1	5.00000	0.12500		Measure Tool 1
2	5.00000	0.12500		Measure Tool 2
3	5.00000	0.12500		Measure Tool 3
4	5.00000	0.12500		Measure Tool 4
5	5.00000	0.12500		Measure Tool 5
6	5.00000	0.12500		Measure Tool 6
7	5.00000	0.12500		Measure Tool 7
8	5.00000	0.12500		Measure Tool 8
9	5.00000	0.12500		Measure Tool 9
10	5.00000	0.12500		Measure Tool 10

## Chapter 2.6.2: Tool Measurement

Do not run the probe cycle for any tool sticking out more than 1.5 inches from the end of the extended tool holder. Doing so will cause a crash and may result in damage to your machine and/or a broken tool.

Install the tool that you wish to measure.

Click on the “Measure Tool xx” button for the tool for which you wish to set the tool length offset.

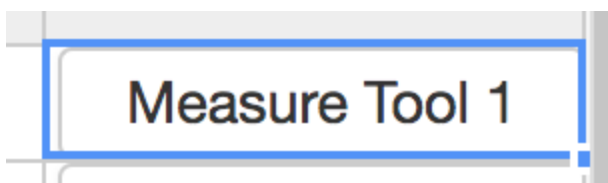

The following prompt will appear in the bottom right corner of the screen.

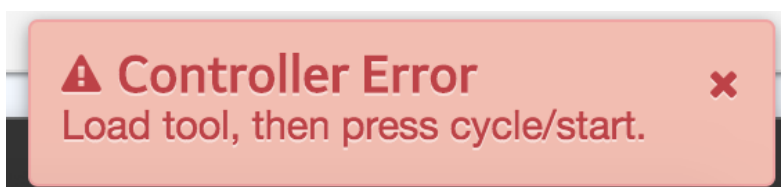



Double check that your tool is installed correctly then switch back over to the Production tab and click on the “Resume/Pause” button or click on the green button on the machine to run the probe cycle.



## Chapter 2.7: Configurations

The configurations tab allows the user to make changes to the Pocket NC software settings.

### Chapter 2.7.1: Network

The network settings displays the machine’s IP address, Host Port, Username and Password. The username and password are both set as “default.”

The Network tab is for configuring your Pocket NC to be on a network. By default, your Pocket NC is configured to connect to 192.168.7.2, the address that is automatically assigned when plugged in to your computer via USB. Advanced users can connect the Pocket NC to a network via ethernet. The IP address assigned to the Pocket NC can be changed in the Network tab so that it can be accessed by other computers on the network. Once on the network, there are serious safety and security considerations to account for. Setting up your machine this way is not recommended unless you fully understand the ramifications of doing so.

Note, that changing the IP address in the network tab does not change the Pocket NC’s IP address, but rather indicates to the UI what address to connect to. If you’ve configured your Pocket NC to be on a network, set its IP address here.





POCKET NC

Production Tooling **Conf.**

Configuration

Network **Display** Jogging Server Version

### Settings for Connecting to LinuxCNC Server over the Network

Host IP Address

Host Port

Username

Password

## Chapter 2.7.2: Display/Changing Unit System

The unit system of the interface may be changed using the “Display” tab. Select the unit system that you would like to use then click “save.” The numbers throughout the interface will update to reflect the new unit system.

POCKET NC

Production Tooling **Conf.**

Network **Display** Jogging Server Version

### Settings for Display of Information

Display Units

Click here to reset to the previous setting

Click here to apply and save changes to the unit system



### Chapter 2.7.3: Jogging

The settings for the keyboard controlled jogging may be changed using this screen. Please note that these settings only apply to the keyboard controlled jogging they do not affect the jog settings for the mouse wheel jogging or the manual jog using the +/- buttons.

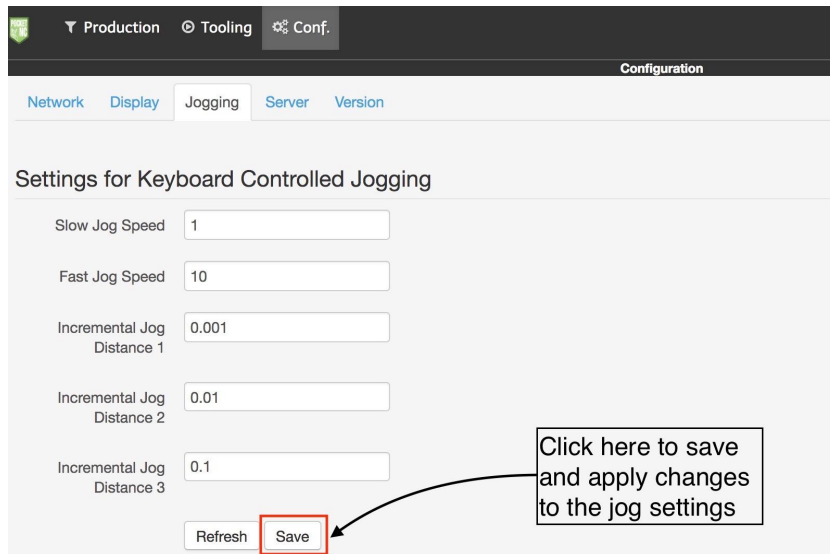

### Chapter 2.7.4: Server

The "Server" tab contains links to the configuration and support pages for the LinuxCNC operating system running on the Pocket NC's BeagleBone computer.



Network   Display   Jogging   **Server**

## Settings for The LinuxCNC Server

Linux CNC Server Web Configuration   [Launch In New Window](#)

Server Help Website   [Launch In New Window](#)

The "Linux CNC Server Web Configuration" link opens a new window that displays all of the settings that the Pocket NC is using to run its specific configuration of Linux CNC. These values are set during the manufacturing and calibration process. These are advanced settings, we recommend that only experienced users change them. Any changes made here are at your own risk and may result in adverse impacts on the Pocket NC's functionality.

© 192.168.7.2:8000

[Configure](#)   [HAL Setup](#)   [HAL Graph](#)   [System](#)   [Security](#)   [Status](#)   [Commands](#)   [Server Doc](#)   [Sandbox](#)

### LinuxCNC Configuration Page:



This tab allows editing of the INI file which controls the high-level behavior of the linuxcnc system. This is where the machine setup is described, such as how many axes of motion will be controlled, what kind of user interface will be used, and how fast motors will turn.

A list of all available commands is available in the [linuxcnc INI Configuration Documentation](#).

[Add New Section](#)   [Remove Section](#)   [Add New Value](#)   [Save Configuration](#)

**INI File**   **Section: AXIS\_0**

**Sections:** General parameters for the individual components in the axis control module. The axis section names begin numbering at 0, and run through the number of axes specified in the [TRAJ] AXES entry minus 1.

AXIS_0	NAME	VALUE	COMMENT	HELP	ACTION
AXIS_1					
AXIS_2					
AXIS_3	BACKLASH	0.000		Backlash in machine units. Backlash compensation value can be used to make up for small deficiencies in the hardware used to drive an axis. If backlash is added to an axis and you are using steppers the STEPGEN_MAXACCEL must be increased to 1.5 to 2 times the MAX_ACCELERATION for the axis.	 
AXIS_4					

The "Server Help Website" link opens a new window with an extensive library of support documentation for the LinuxCNC operating system that the Pocket NC mill runs.



192.168.7.2/external/linuxCNCDoc//linuxCNCDocumentation/www.linuxcnc.org/docs/html/index.html

This documentation refers to LinuxCNC version **2.5.2**.

- Other languages available: [Deutsch](#) [Español](#) [Français](#) [Polski](#)
- [LinuxCNC Document Overleaf](#)
- [LinuxCNC G Code Quick Reference](#)
- [LinuxCNC Wiki Community](#)
- Getting Started with LinuxCNC
  - [System Requirements](#)
  - [Getting LinuxCNC](#)
  - [Updating LinuxCNC](#)
  - [Stepper Quickstart](#)
  - [Stepper Configuration Wizard](#)
  - [Mesa Configuration Wizard](#)
  - [Running LinuxCNC](#)
  - [Stepper Diagnostics](#)
  - [Linux FAQ](#)

## Chapter 2.7.5: Status

The “Status” tab contains information on the system and its current state. This tab allows the user to see the disk usage of the machine as well as clear logs and g code files by clicking the respective buttons.

The screenshot shows the 'Status' tab of the LinuxCNC web interface. At the top, there are navigation tabs: Network, Display, Jogging, Server, Status (selected), and Version. Below the tabs, the 'System Status' section is displayed. It includes a sub-section for 'System Date and Time' showing 'Wed Mar 20 2019 09:48:58 GMT-0600 (Mountain Daylight Time)' and a button to 'Set System Time To This Computer's Time'. The 'IP Addresses' section shows 'No IP addr' and the IP address '192.168.7.2'. The 'Disk Usage' section features a progress bar indicating '65.95% - System Files' with a '3.' label. At the bottom, there are two red buttons: 'Clear Logs' and 'Clear G Code Files'.



## Chapter 2.7.6 Version

The “Version” tab contains information on what software and hardware versions the machine is running. In this tab the user is also able to update the software version they are running as well as change whether they are using a V1 or V2 machine.

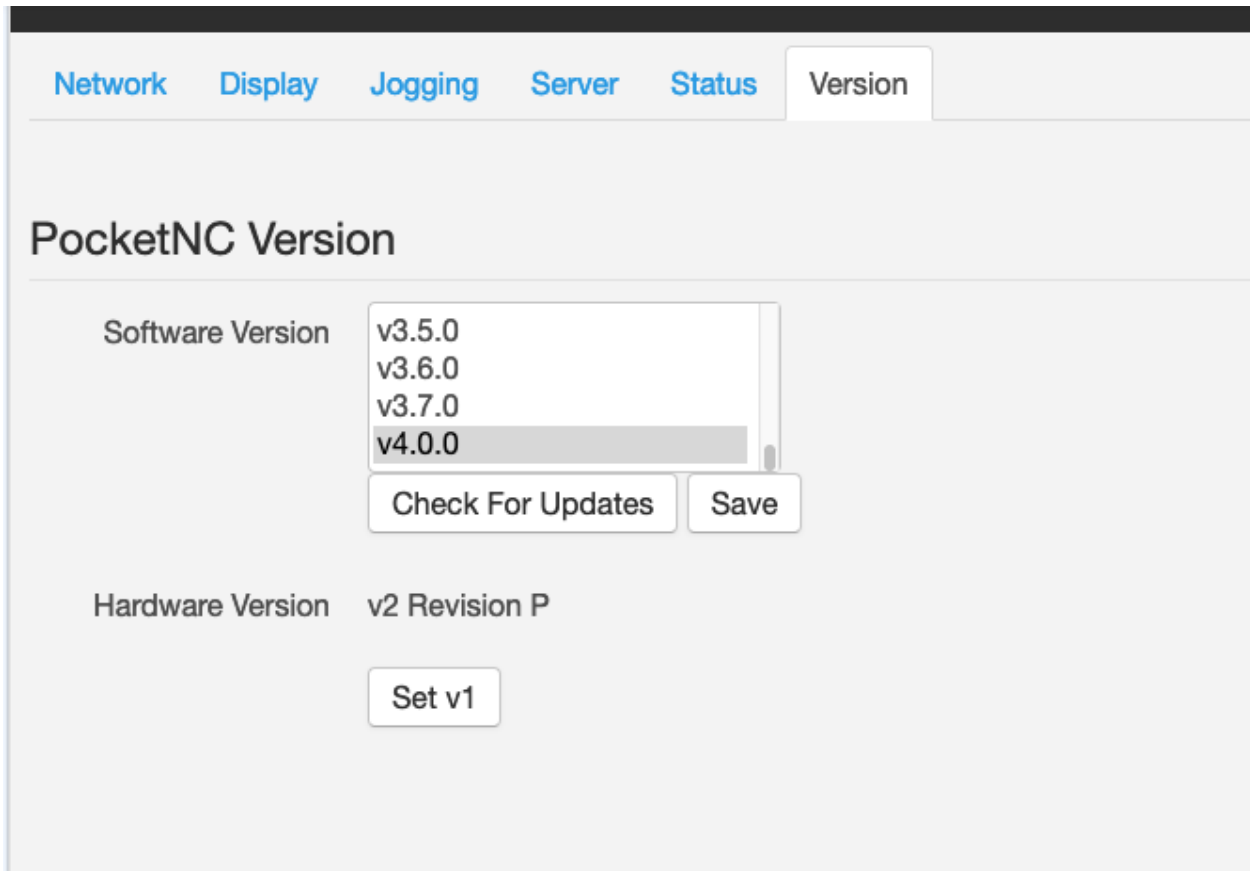

## Chapter 3: Machine Operation

### Chapter 3.1: File Management

Once you have created your G-code toolpath in Fusion 360 or other CAM software, you will need to transfer it to the machine in order to be able to run it. Note that G-code files must be 2.5MB or less to transfer. This is also the maximum file size that the Pocket NCs’ processor can handle when it comes time to check the G-code for errors before running it.



## Chapter 3.2: Loading Files

Upload a machining file to the BeagleBone by clicking on the “Upload New File” button.

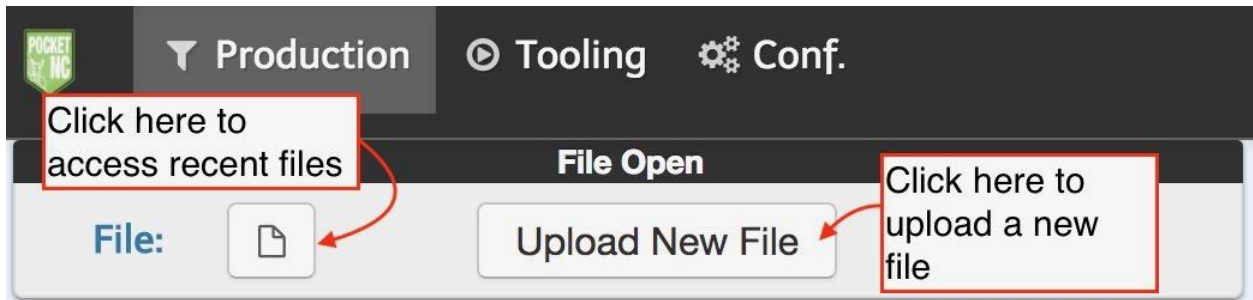

Select your .ngc file from the file directory on your computer or USB flash drive plugged into your computer.

After the file has been successfully uploaded, the file name will appear in the in the file window on the left side of the screen as well as in the file display window at the bottom of the screen.

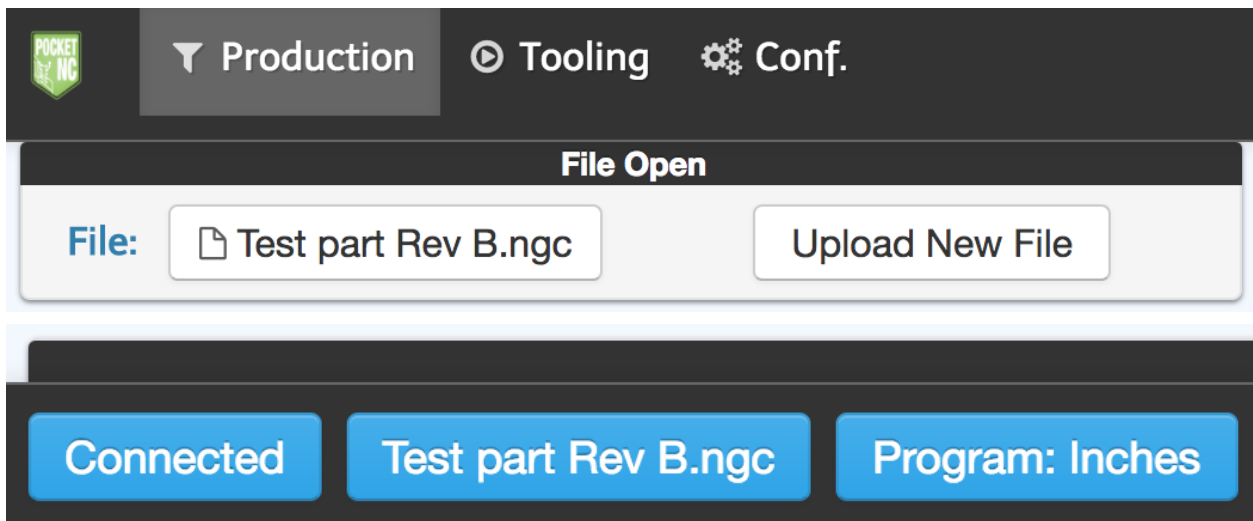

Once the file is loaded, the code will be displayed in the “File” display area at the bottom of the screen. The user can view the file before running it and while it runs using this interface.



File	
0	%
1	( <i>AXIS,stop</i> )
2	(1)
3	<i>N10 G20</i>
4	<i>N15 G90 G94 G40 G17 G91.1</i>
5	<i>N20 G53 G0 Z0.</i>
6	( <i>CONTOUR1 2</i> )
7	<i>N25 M9</i>
8	<i>N30 G49</i>

### Chapter 3.3: Running a Program

Once a program is loaded, run the program by clicking the green “Run From” button.

The Run control panel features a black header with the word "Run" in white. Below the header, there is a green "Run From:" button with a play icon, followed by a white input field containing the number "0". To the right are a blue "Pause" button with a double vertical bar icon and an orange "Stop" button with a square icon. Below these buttons, there is an "Optional Stop:" section with a green "ON" toggle switch. To the right of the toggle are two vertical sliders. The first slider is labeled "Feed Rate" and is set to "100%", with a refresh icon and up/down arrow buttons below it. The second slider is labeled "Spindle Rate" and is set to "0%", also with a refresh icon and up/down arrow buttons below it.

If you have an M0 (or M1 with optional stop on) command at the start of your code, the program will be paused. Click the blue “Pause/Resume” button or push the green Pause/Go button on the machine in order to start the program. The user may pause the program at any point by clicking the “Pause” button or pushing the green button on the machine. The user can stop the program by clicking the “Stop” button or pushing the red, emergency stop button on the machine.



### Chapter 3.4: Deleting a File

Click on the file button to access the files that have already been loaded. Click on the “X” next to the file to delete the file from the BeagleBones’ memory.

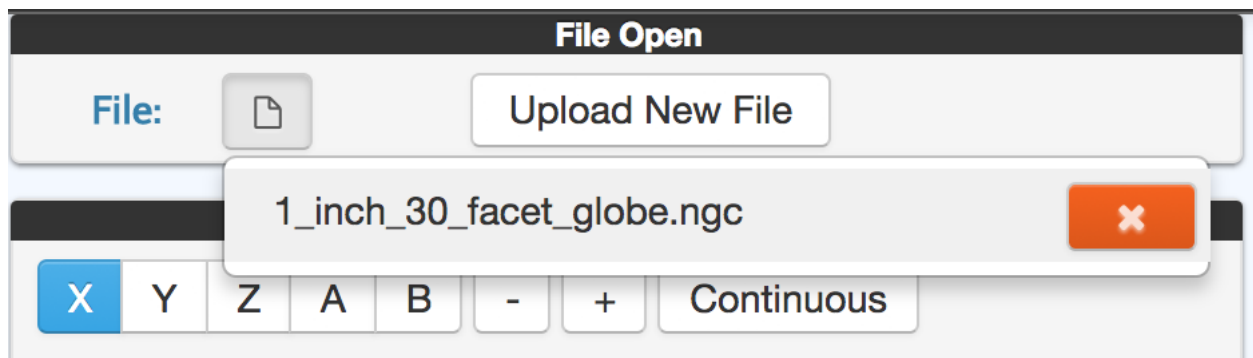

### Chapter 3.5: V2-10 and V2-50 Tooling

This section describes tool management of the Pocket NC 5 axis Mill: commanding tool changes, loading tools into holders, setting CNC tool offsets. The following is written for V2-10 machines. V2-50 users will follow the same steps except for those related to the tool holders.

#### Chapter 3.5.1: V2-10 Tool Holders

The Pocket NC 5 axis mill requires a specific type of tool holder. Each tool holder has a taper that matches that of the Pocket NC spindle. Tool holders are interchangeable and allow for the use of multiple tools with minimal effort between tool changes. Three types of tool holders exist, the short, standard tool holder, the long, extended tool holder, and the edge finding tool holder.





The standard and extended tool holder both use an ER11 collet system for holding tools. The collets are available in Standard and Metric sizes ranging from 1/8 inch to 5/16 inch and from 3 mm to 6 mm.

The edge finding tool holder uses set screws to retain the tool. It is only compatible with 3/8 inch diameter tool shanks.



### Chapter 3.5.2: Tool Holder Care

Make sure to keep the tool holders clean. Take special care to remove debris and oil from the inside taper before installing a collet or tool and the outside taper before installing the tool holder in the spindle. Use a soft, lint-free cloth and isopropyl alcohol to clean the tool holders.

Put a thin coat of light oil on the tool holders and collets if they are going to be stored for a long period of time, this will help to prevent rust. Remove the oil before using them.



Before operating the spindle, make sure that all of the set screws are tightened evenly and snugly and that the collet nut is tightened securely.

### Chapter 3.5.3: Tool Setup and Holder Setup

Each tool holder consists of 4 components; tool holder, ER11 collet, collet nut and end mill tool or other. Tooling is secured within a tool holder using a standard ER11 collet and collet nut.

First install the tool holder in the Pocket NC spindle and fasten with 3 M4 set screws. Do not tighten down one set screw completely without starting the other screws. Doing this may cause the tool holder to be pushed off center so that it will not spin concentrically with the spindle. Instead, start each of the set screws and screw in only until each screw starts to touch the tool holder. Then go back around and incrementally snug the set screws down.

Install the appropriate collet for your tool shank diameter into the collet nut. Push the collet in until it snaps behind the retaining ring. It should not fall back out of the collet. It will still be able to wobble some. The user may either install the tool in the collet now or he may partially install the collet nut onto the tool holder then insert the tool.

After the tool is installed in the collet, spin the collet nut onto the tool holder by hand. Make sure that it is not cross threaded. Adjust the tool stickout, how far the tool sticks out of the collet, to the desired length. Under no circumstances may the butt end of the tool not extend through the entire length of the collet. The tool will not be retained safely if the collet does not grip the shaft fully.

Tighten the collet nut with the provided 17mm spindle wrench. Use the provided 3mm hex driver in one of the spindle set screws to keep it from rotating with the collet nut.



### Chapter 3.5.4: Tool Setup

Before the tool can be used to cut material it must be measured so that the Tool Length Offset can be determined.

The tool length offset (TLO) is the distance between the Z home position and the machine home when the tip of the tool is a specified distance from the B-table. Basically, this tells the Pocket



NC where the tool is in space so that the correct compensations can be made to the program in order to cut the part accurately and successfully.

The Pocket NC V2 is equipped with a tool probe that will automatically measure the tool length offset for most tools. However, some tools will still have to be measured by hand. This section will explain how to use the automatic tool probe as well as how to measure the tool length offset by hand.

The 1/8" single flute endmill shipped with your machine has been set up in the Pocket NC tool library, which can be found in the "V2 First Part Tutorial" on our website. (Part Number 528508 - Carbide, Plastic Cutting End Mill - Square Up-cut Single Flute). Do not use for plunging or for cutting metals.

Pocket NC offers a number of other tools that are suitable for a range of materials up to and including steel. See the Pocket NC website for details on the tooling available.

## Chapter 3.5.5: Tool Change

### *Chapter 3.5.5.1: Tool Holder Change*

1. Turn off spindle and loosen the (3) spindle screws using the 3mm driver.
2. Tap spindle holder with the back end of the 3mm driver and take out the tool holder.
3. Reverse process for installing a new tool holder, being sure to tighten the (3) spindle screws evenly.

### *Chapter 3.5.5.2: Tool Change*

1. Use the Pocket NC spindle wrench and the 3mm driver (provided in the tool kit).
2. Turn off spindle and place the 3mm driver into one of the 3 spindle screws.
3. Using the Pocket NC spindle wrench loosen the collet nut while holding the spindle in place using the 3mm driver.
4. Change out or move tool and then reverse the process to tighten the tool holder.
5. Remember to adjust or remeasure the tool offset after changing or adjusting a tool.

### *Chapter 3.5.5.3: V2-50 Tool Change*

1. Turn lever on V2-50 spindle to the "open" position.
2. Insert tool to desired stick-out
3. Turn lever back to the "lock" position



### Chapter 3.5.6: Using the Tool Probe

Do not run the probe cycle for any tool with a diameter larger than .25” or that is sticking out more than 1.5 inches from the end of the extended tool holder. Doing so will cause a crash and may result in damage to your machine and/or a broken tool.

The Tool Table is found under the Tooling tab in the user interface.

The screenshot shows the Pocket NC user interface with the Tooling tab selected. The DRO section displays coordinates for X, Y, Z, A, and B axes. The Work Offsets section shows G53 and G92 settings. The Tool Table section displays a list of tools with their Z Offset, Diameter, and Description.

	Z Offset	Diameter	Description
1	5.00000	0.12500	Measure Tool 1
2	5.00000	0.12500	Measure Tool 2
3	5.00000	0.12500	Measure Tool 3
4	5.00000	0.12500	Measure Tool 4
5	5.00000	0.12500	Measure Tool 5
6	5.00000	0.12500	Measure Tool 6
7	5.00000	0.12500	Measure Tool 7
8	5.00000	0.12500	Measure Tool 8
9	5.00000	0.12500	Measure Tool 9
10	5.00000	0.12500	Measure Tool 10
11	5.00000	0.12500	Measure Tool 11
12	5.00000	0.12500	Measure Tool 12
13	5.00000	0.12500	Measure Tool 13
14	5.00000	0.12500	Measure Tool 14
15	5.00000	0.12500	Measure Tool 15

The “Z-Offset” column displays the tool length offset that is set for the tool. All the tools are set to 5.000 inches by default. The “Diameter” column displays the tool diameter. Note that this is the diameter of the cutter not the diameter of the shank. All the tools are preset to 0.125 inches by default. The user can add a description of the tool in the “Description” column.



Tool Table				
	Z Offset	Diameter	Description	
1	5.00000	0.12500		Measure Tool 1
2	5.00000	0.12500		Measure Tool 2
3	5.00000	0.12500		Measure Tool 3
4	5.00000	0.12500		Measure Tool 4
5	5.00000	0.12500		Measure Tool 5
6	5.00000	0.12500		Measure Tool 6
7	5.00000	0.12500		Measure Tool 7
8	5.00000	0.12500		Measure Tool 8
9	5.00000	0.12500		Measure Tool 9
10	5.00000	0.12500		Measure Tool 10

Install the tool that you wish to measure. Make sure to tighten the collet nut and the set screws.

Click on the “Measure Tool xx” button for the tool that you wish to set the tool length offset.

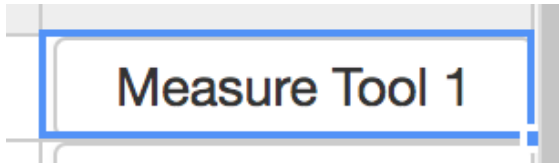

The following prompt will appear in the bottom right corner of the screen.

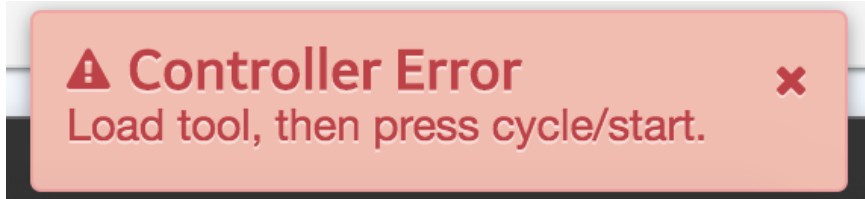

Double check that your tool is installed correctly then switch back over to the Production tab and click on the “Resume/Pause” button or push the green button on the machine to run the probe cycle.



After the probe cycle has finished, the tool length offset will be updated in the tool table.

	Z Offset	Diameter	Description
1	-3.08229	0.12500	Measure Tool 1
2	5.00000	0.12500	Measure Tool 2
3	5.00000	0.12500	Measure Tool 3
4	5.00000	0.12500	Measure Tool 4
5	5.00000	0.12500	Measure Tool 5
6	5.00000	0.12500	Measure Tool 6

Pictures of the tool probe cycle are shown below.

The first move in the cycle is to move as far back in the Z axis as possible which prevents collisions.

The tool probe button is located on the side of the B-table housing.

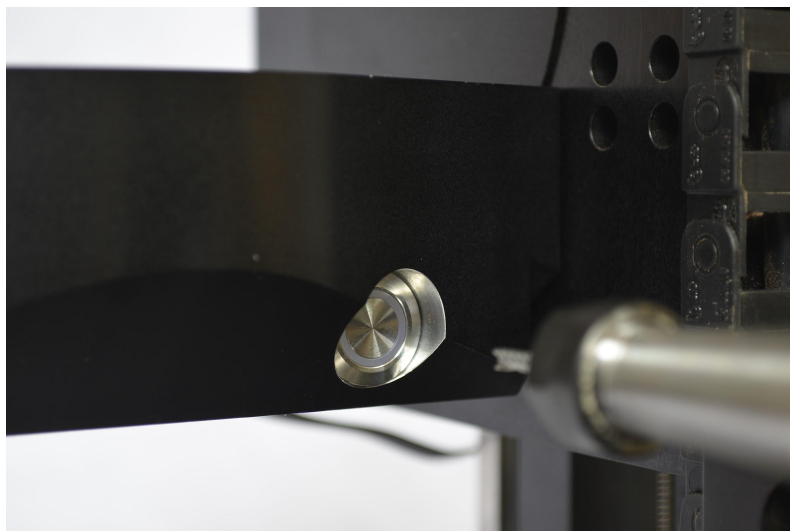

The tool will advance until it triggers the tool probe button. It will then retract a short distance, then approach at a lower speed until the button triggers again.



After the cycle is finished, the machine will return to the position it was in when the the cycle was started. Note that this could cause a collision with the part if you are swapping out a shorter tool for a longer tool. Program/adjust your G-code appropriately to avoid this type of collision by retracting to a safe distance before a tool change. The Pocket NC post processor in Fusion 360 will automatically send all axes to their home positions before a tool change.

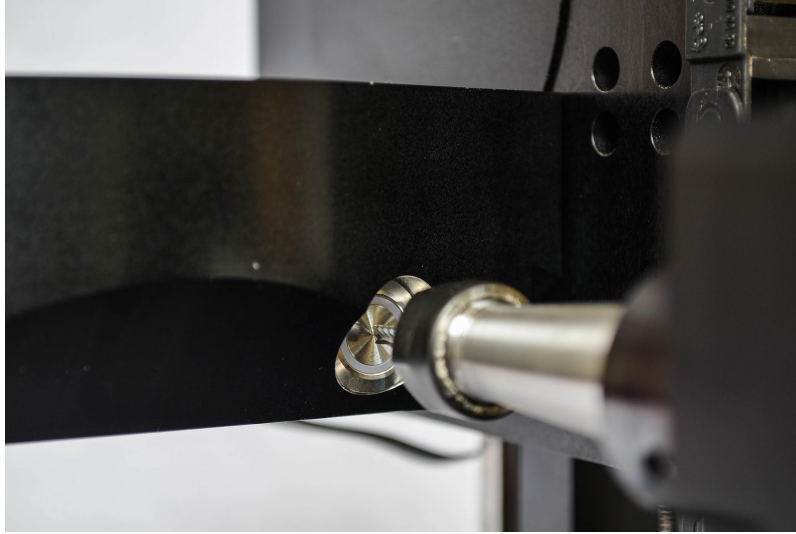

### Chapter 3.5.7: Measuring the Tool Length Offset by Hand

If the automatic tool length measurement probe cannot be used for a tool, you can measure the tool length offset by hand.

You will need to know your machine's B-Table Offset. This is the distance from B-Table to Center of A axis rotation. This number is around 0.8xx inches. This value changes for each machine and is included in the paperwork that comes with the machine. If you have misplaced yours, please email us at [info@pocketnc.com](mailto:info@pocketnc.com) and we can find it for you!

You will also need a 1-2-3 block. Any 1-2-3 block can be used for this procedure. They can usually be purchased on Amazon fairly inexpensively.





### Chapter 3.5.7.1: Tool Offset Setup Procedure

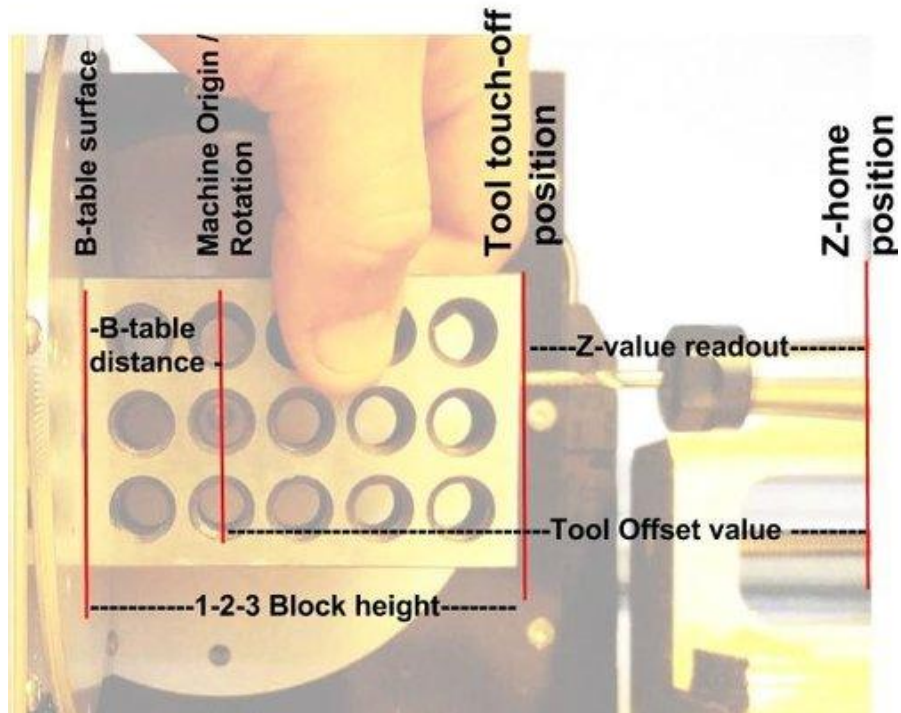

1. Home all axes on the machine.
2. Clear any offsets by clicking on either of the offsets listed and clicking "Zero All Offsets" from the dropdown list.



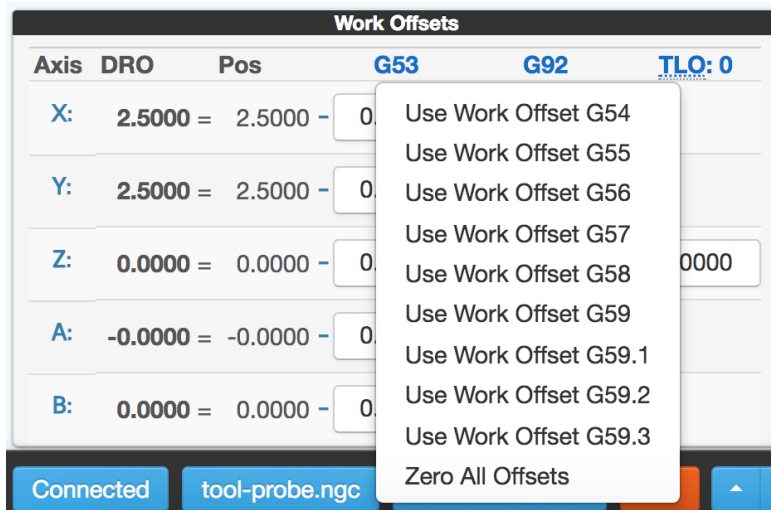

3. Move A table to 90 degrees using the command “g90 g0 A90” within the MDI command window.

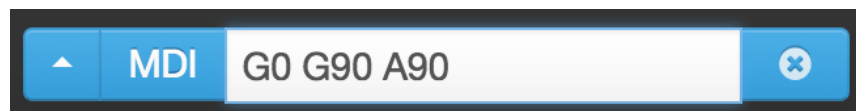

4. Clean off any debris on the B-table. Hold the 1-2-3 against the B-table with the long edge of the block parallel to the tool. Make sure that the 1-2-3 block is flush with the B-table and that you have it against the center part of the B-table (the raised part that rotates), not the B-table housing (the part that doesn't rotate).

5. Jog Z in the negative direction until the tip of the tool is close enough to the B axis table that the 1-2-3 block will not fit between the two.

6. In increments of 0.01” or less, jog the Z axis positive until the 1-2-3 block slides between the tool and the table

7. Repeat this step with smaller increments until the tool position is measured past 3 decimal places

8. Use the current Z position on the Machine interface to calculate the tool offset using the equation below:



$$-(1-2-3 \text{ block height}) + (\text{B-table distance "above"}) + (\text{Z value readout}) = (\text{Tool Offset})$$

$$\text{Example } -(3.000)+(0.8861)+(-0.9131)=(\text{Tool Offset}) = (-3.027)$$

9. Input the calculated Tool Offset in the tool table for the appropriate tool. Click in appropriate box in the "Z-Offset" column. Enter the tool offset that you calculated. Make sure that the sign is correct. Update the tool diameter if needed.

### Chapter 3.6: Feeds and Speeds

The Pocket NC mill removes material using a tool with a series of small rotating cutting edges. A tool with 2 cutting edges will make two cuts for each revolution. The material that is removed is referred to as a chip. The thickness of a chip that the Pocket NC is capable of producing will vary depending on what material is being removed and what cutter is being used.

The thickness of a chip(also called the chip load) is adjusted using two variables, feed and speed. Feed refers to the linear rate in inches/minute or millimeters/minute that the cutting tool moves through a material. Speed refers to the rotational speed in RPM (revolutions per minute) of the cutting tool. To increase chip load, speed can be decreased or feed can be increased.

Every material has a different ideal chip load. There are many resources available in print and online that list suggested chip loads for many materials.

For example, assume that the ideal chip load for a given material is 0.001". This means, with a spindle speed of 10,000 RPM and a linear progression of 0.002" per revolution (2 cutting edges X 0.001") gives a feed of 20 inches per minute. It is important to keep in mind that the calculated chip load is only a guideline or starting point, the user should adjust the speed and feed to what sounds good and feels good. Feed and speed can be adjusted on the fly using the Pocket NC user interface.

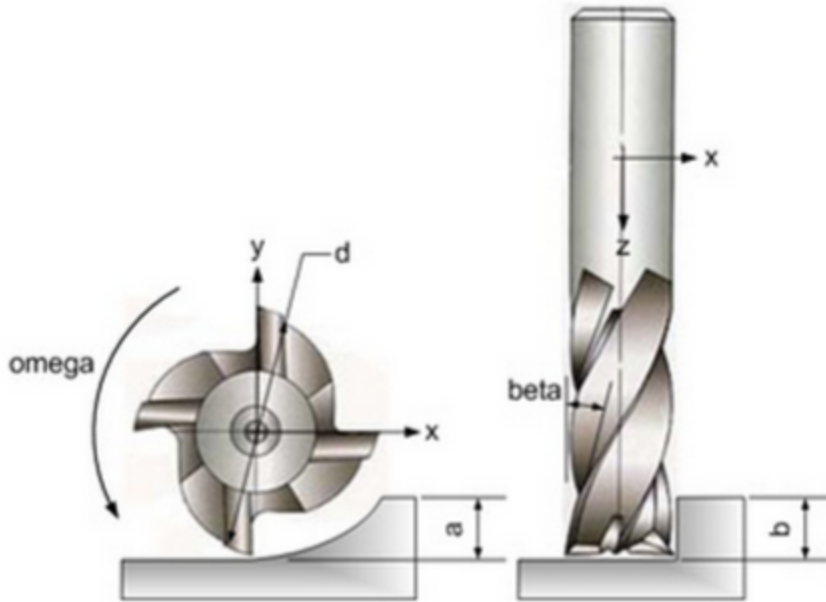

Machining also has two more variables, side load and depth of cut. These two variables will change the width and length of the chip being removed from the material. Dimension “a” in the image above represents the amount of material removed with the cutting tool in the X/Y direction or side load. Dimension “b” in the image above represents the amount of material removed with the cutting tool in the Z direction, also known as the depth of cut.

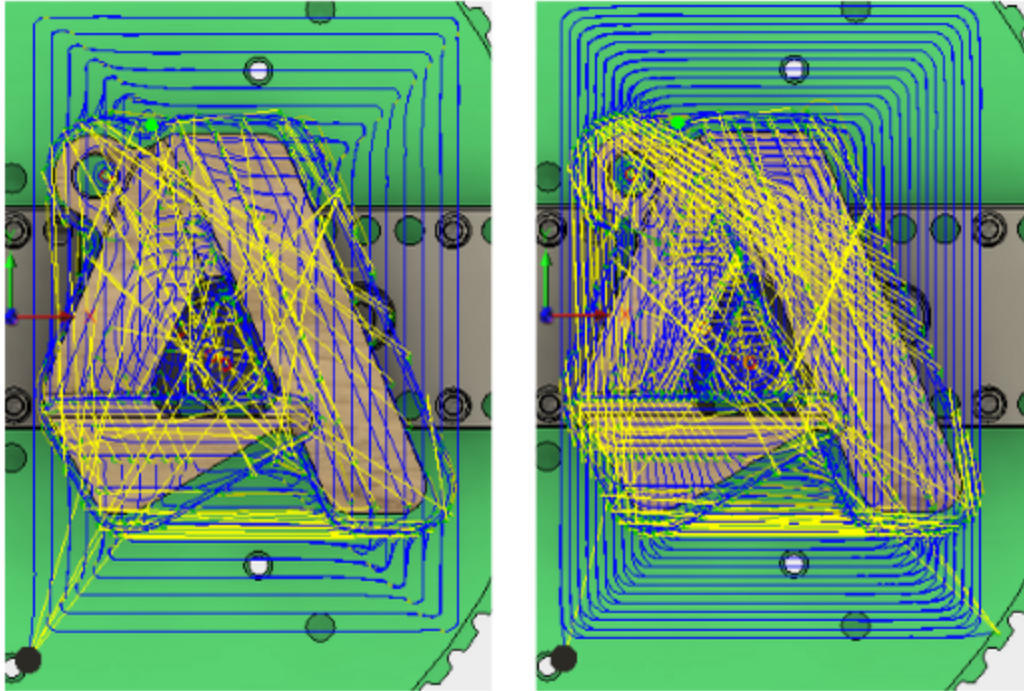

Above, the image on the left shows a tool path with a side load of 0.08" and the image on the right shows a tool path with a side load of 0.04". If the material being removed was soft like wax or wood, the tool path on the left would be much more appropriate as the machine will be able to handle that amount of side load. If the tool path from the image on the right was used with the same material, the user would have spent twice as much time and worked the spindle half as hard.

To adjust side load and depth of cut in Fusion 360 see the images below.

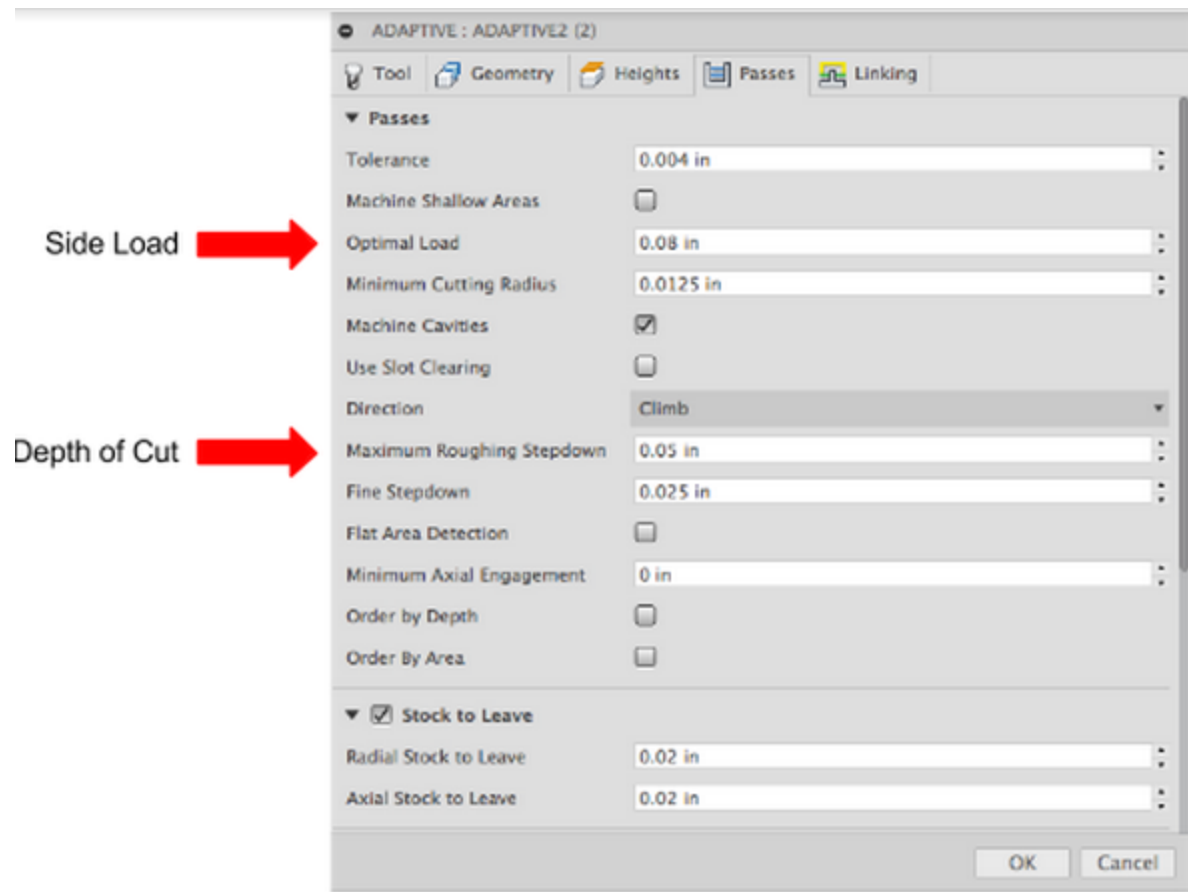

Feed and speed can be adjusted from the Tool tab for each tool path. Below, spindle speed is marked with a blue arrow and feed is marked with a red arrow.

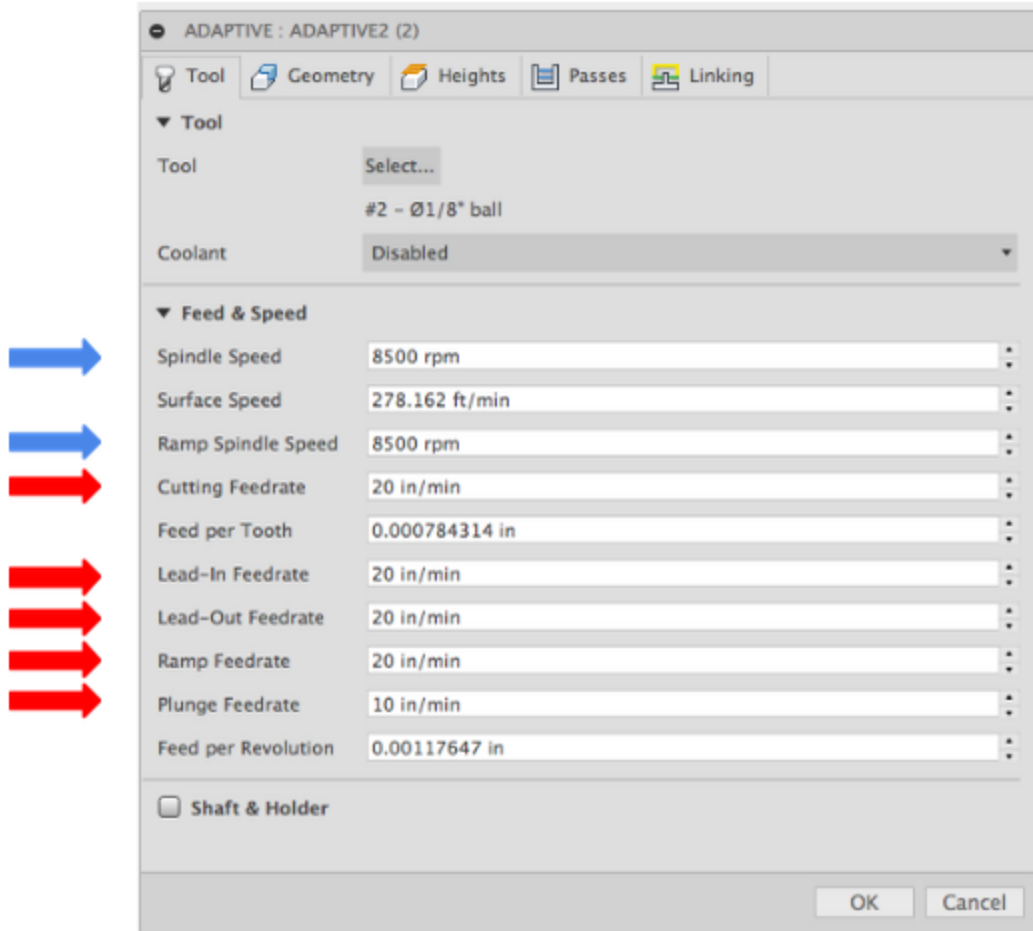

With that said, we have posted a general guideline for the 4 variables below in a number of materials. Note that side load and depth of cut will be expressed as a percentage of tool diameter and feed will be represented as feed/tooth. For example, the end mill pictured above has 4 cutting teeth. To calculate feed, use the following equation.

$$\text{Feed in IPM (inches per minute)} = (\text{feed in inches per tooth}) \times (\# \text{ of cutting teeth}) \times (\text{spindle speed in RPM})$$

Use this as a starting point for your feed and speed and make adjustments as you go.



	Speed (RPM)	Feed per tooth (in)	Depth of Cut	Side Load
Copper	8,500	0.0005	90%	10%
Aluminum	8,500	0.0008	90%	10%
Hard Plastic	8,500	0.001	80%	50%
Soft Plastic	8,500	0.0015	70%	60%
Hard Wood	8,500	0.001	70%	60%
Soft Wood	10,000	0.002	50%	70%
Wax	10,000	0.003	50%	70%

## Chapter 3.7: Part Setup

### Chapter 3.7.1: Pocket NC Vise

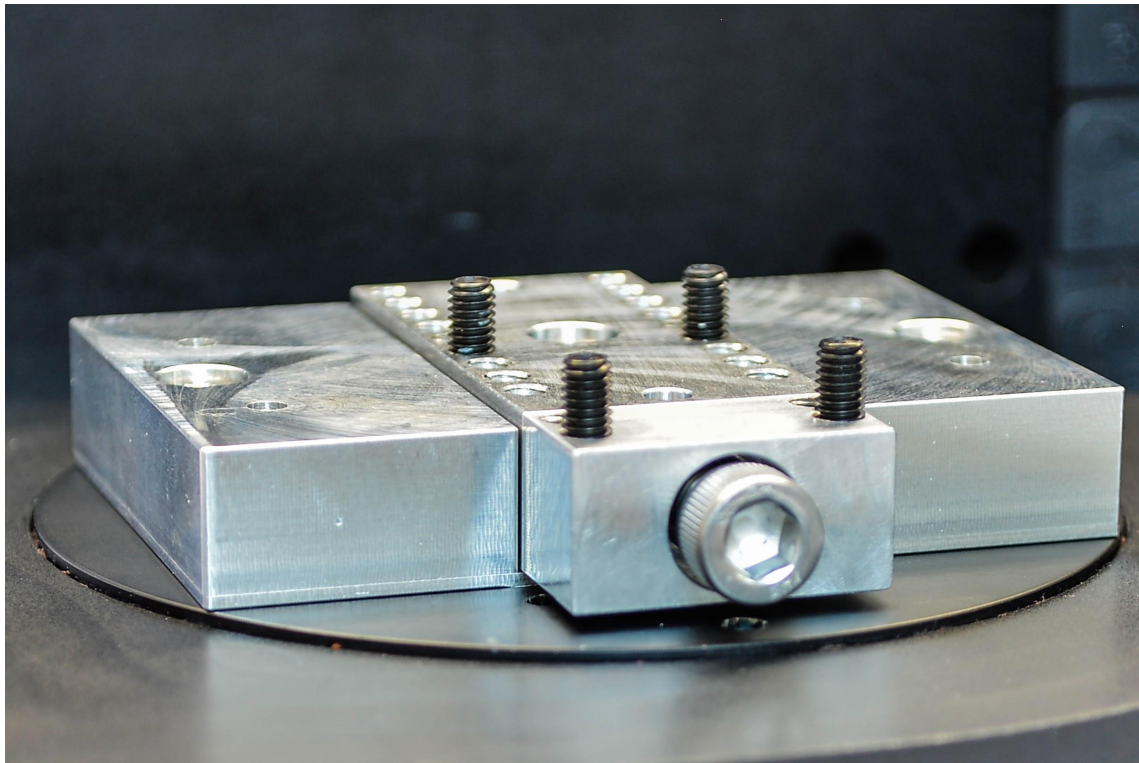





### Chapter 3.7.1.1: How to Use the Pocket NC Vise

The Pocket NC vise was designed to be super adjustable and have excellent grip. While it does not look like a traditional vise the function is the same. Dowel pins and/or set screws are used in place of jaws and are completely interchangeable. M4 set screws work like gripper jaws for roughing material and will work for a hardness of aluminum and anything softer. Dowel pins can be used for light finishing work. The pins can be adjusted in increments of 5 mm. The movable jaw has a travel of 6mm with 6+ mm of thread engagement.

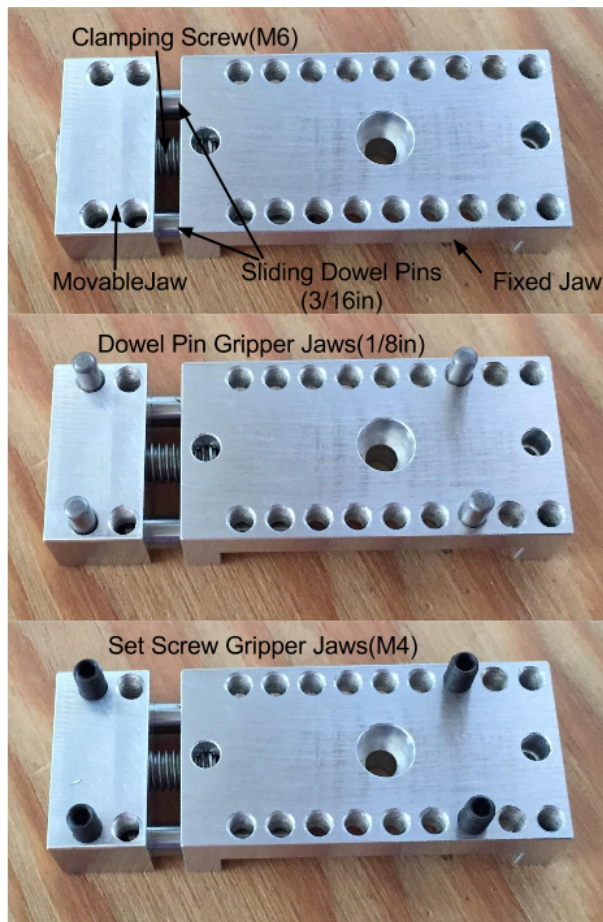





Mounting the vise to the PocketNC V2 mill requires an adapter to bridge the hole in the center of the B-table.

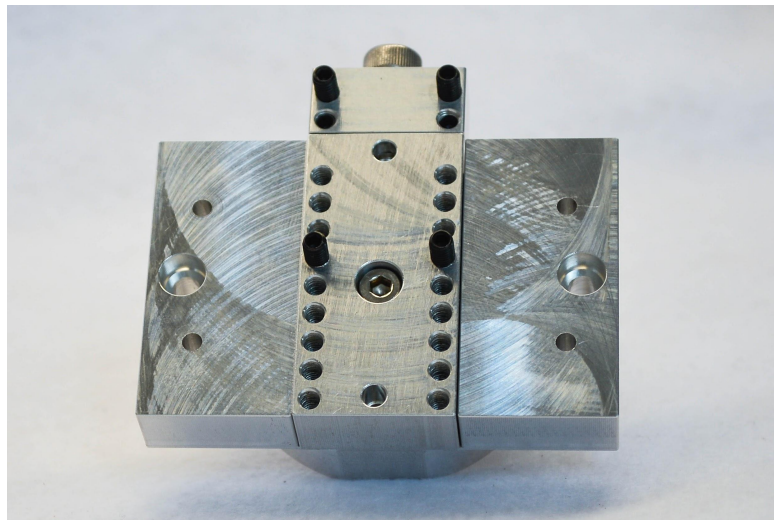
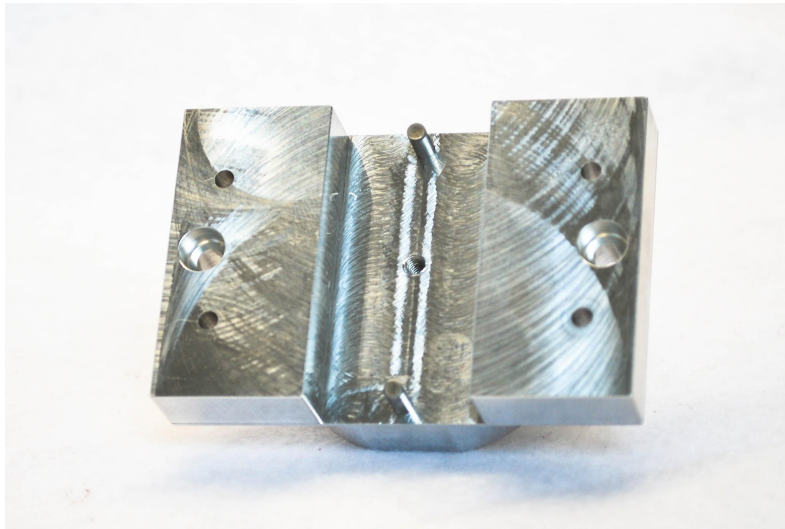

The adapter mounts onto the B-table of the PocketNC using two  $\frac{1}{8}$  inch dowel pins and two M4 x 8 fasteners. The adapter can be installed in any of 8 possible positions on the B-Table.

#### *Chapter 3.7.1.2: Installing the Pocket NC Vise*

Place two  $\frac{1}{8}$  inch dowel pins directly across from one another.

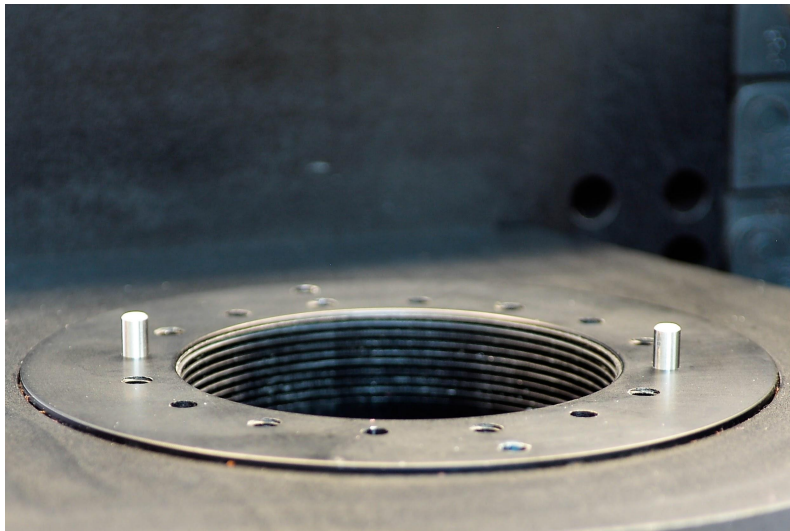

Place the adapter onto the B-table, lining up the holes in the adapter with the dowel pins. You may need to wiggle the adapter as you work it down into place. Make sure that you get the adapter all the way down so that it is flush on the B-table. Install the M4 x 8 fasteners to fix the adapter in place. Tighten the fasteners only until snug, do not overtighten. Overtightening will damage the threads on the B-table.

Make sure that the bottom of the vise and the bottom and sides of the adapter slot are clean of debris. Place two  $\frac{1}{8}$  inch dowel pins into the dowel pin holes on the bottom of the fixed jaw of the vise. Place the vise into the adapter and wiggle it into place so the bottom of the vise is flush to the mating surface in the vise adapter. Install the M4 x 10 screw, tighten only until snug, do not overtighten. Overtightening will destroy the threads machined into the adapter. A good gauge of an appropriate level of tightness is to tighten the screw with a 3mm hex wrench only to the point that the wrench starts to flex.

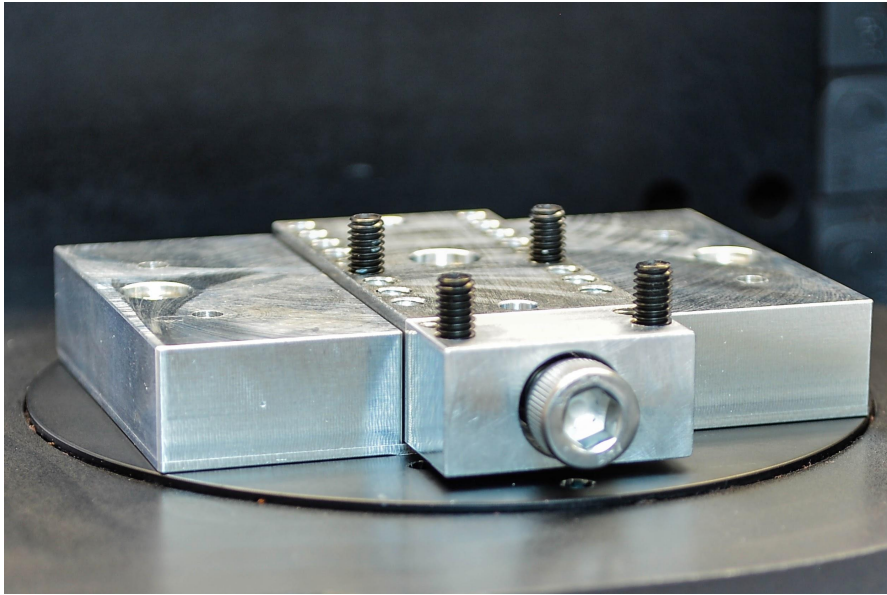

The Pocket NC vise uses 3 different types of off-the-shelf components, socket head cap screw, set screws and dowel pins. You will notice that the fasteners and set screws are metric and the dowel pins are english. We have two reasons for the mix and match. The most common part that will get lost is the  $\frac{1}{8}$  inch dowel pins, they tend to roll off desks and slip out of hands but because they are english units, a replacement or even longer versions can be purchased at a local hardware store. The second reason for this mix, M4 fasteners have a minor diameter that is so close to  $\frac{1}{8}$  inch that a M4 internal thread can be machined to also accommodate an  $\frac{1}{8}$  inch dowel pin. This helps the user easily switch between roughing parts and finishing parts.

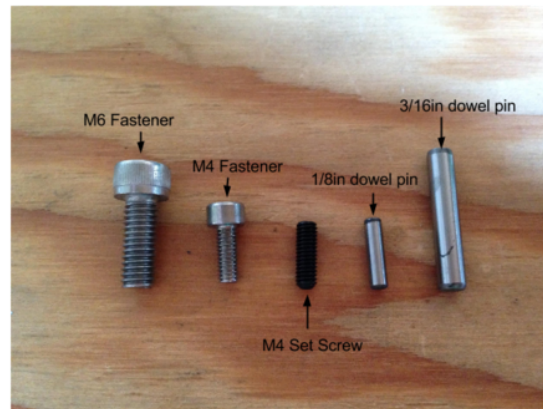

Here you can see the PocketNC vise mounted on the B axis table within Fusion 360.

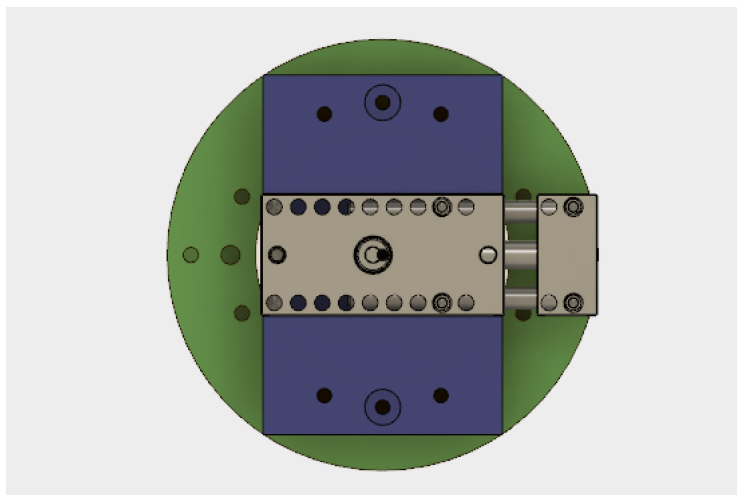
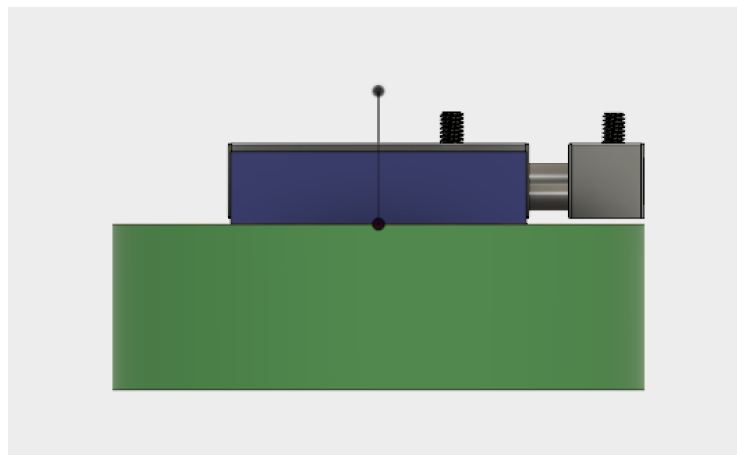



The origin of the machine (X0 Y0 Z0 A0 B0) is represented by a black point (at the end of the black line) centered on the B-table. That point is .885" above the surface of the B-disc and is the machine origin point, otherwise referred to as the "B-Table Offset". Material can be placed within Fusion 360 using this table and vise setup to accurately represent the set-up on the machine. You can find the Fusion file for the vise and table [here](#).

Below is a representation of a sample part being set up for machining.

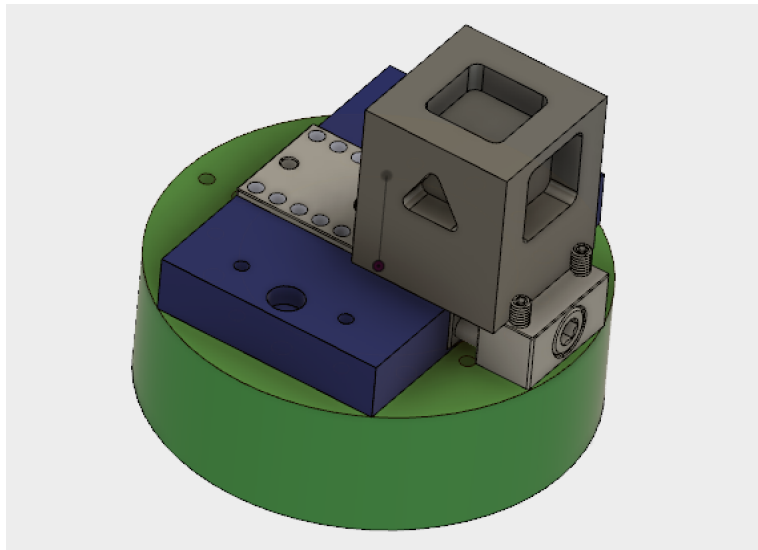

Below is a picture of round wax stock being held in the Pocket NC vise.



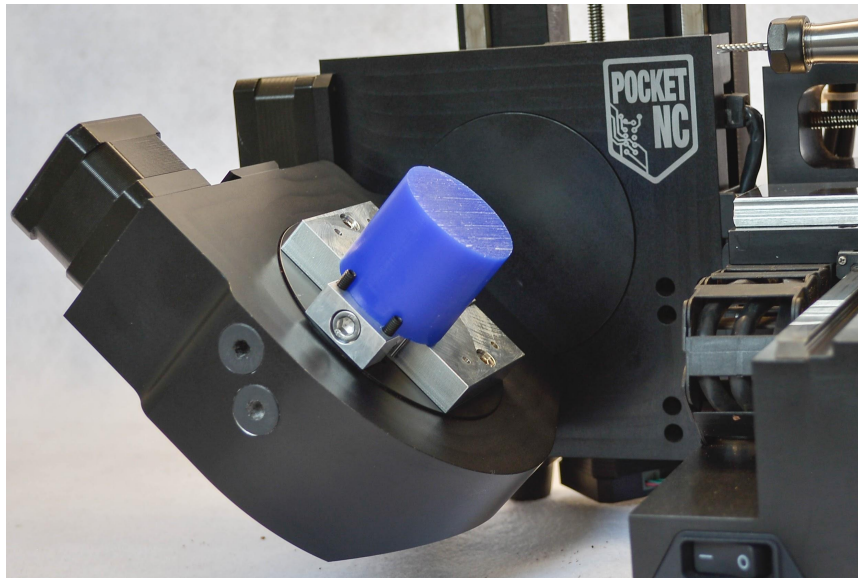

### Chapter 3.7.2: ER-40 Collet System

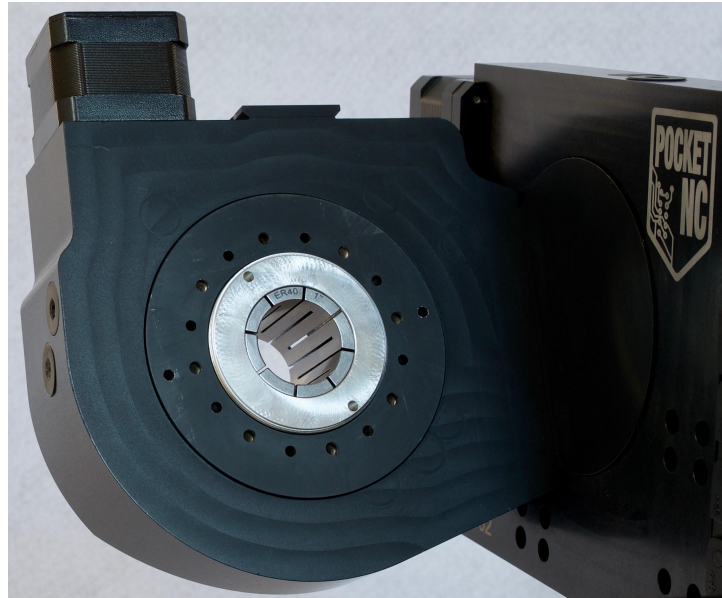

Another way that stock can be mounted on the Pocket NC V2 is using the ER-40 collet system. This is a particularly useful way to hold round stock, especially because the through-hole design allows the user to mount longer parts than could be held in the vise.



The ER-40 collet system consists of three parts, an ER-40 collet (available in a range of internal diameters) a bottom tapered nut, and a top tapered nut. They fit together as shown in the image below.

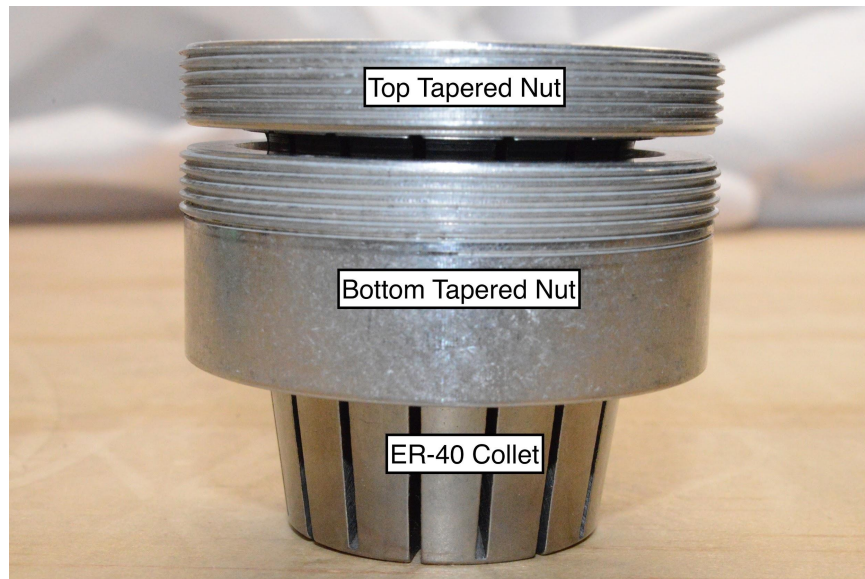

### *Chapter 3.7.2.1 Installing the Collet System*

#### **Step One: Install the Bottom Tapered Nut**

Thread the bottom nut into the B-table. Start the nut by hand to make sure that it is not cross-threaded, then use the provided spanner tool to tighten the bottom nut till it hits the end of the threads.

**DO NOT OVERTIGHTEN!** You will damage the B-table drive system if you use excessive force when tightening the collet nuts. The maximum torque that should be used to tighten the collet is



12 inch pounds (1.36 Nm). The tool provided by Pocket NC is the only recommended way to tighten these nuts. Do not use a standard spanner wrench.

### **Step Two: Install the Collet**

Insert the collet into the bottom tapered nut

### **Step Three: Install the Top Tapered Nut and the Stock.**

Start the nut by hand. Place the stock into the collet. Tighten the collet by hand until the stock is secure, then use the provided spanner tool to tighten the nut.

**DO NOT OVERTIGHTEN!** You will damage the B-table drive system if you use excessive force when tightening the collet nuts. The maximum torque that should be used to tighten the collet is 12 inch pounds (1.36 Nm). The tool provided by Pocket NC is the only recommended way to tighten these nuts. Do not use a standard spanner wrench.







### Chapter 3.7.3 Sacrificial Plate



The third way that you can mount stock on the Pocket NC is with the sacrificial plate.

The sacrificial plate is 4 inches in diameter and made of 6061 Aluminum. It has slots pre-cut for M4 hex nuts and fasteners to allow unusually shaped parts to be mounted in a variety of ways.

The table is also soft enough to be drilled/machined by the user to customize it if needed.

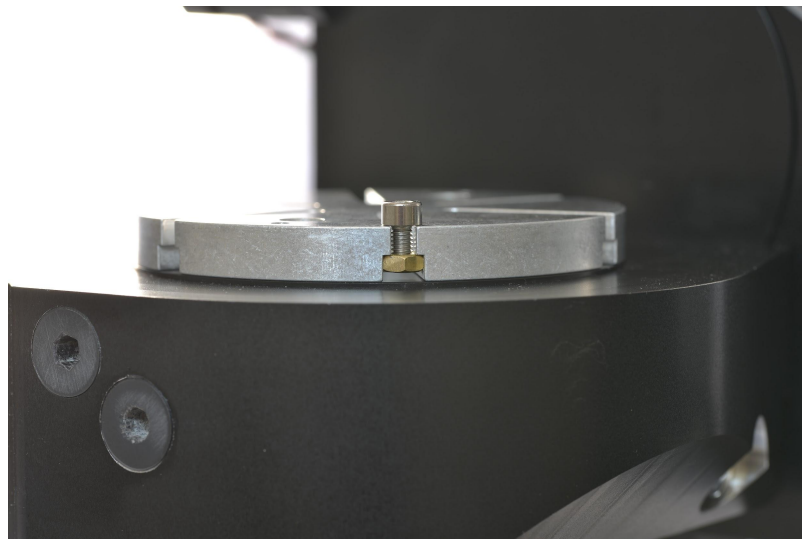



The sacrificial table is mounted to B-table with two  $\frac{1}{8}$  inch dowel pins and two M4 x 8 fasteners. Insert the two dowel pins into the unthreaded holes on the B-table that are furthest from the axis of rotation. Make sure that both the B-table and the underside of the sacrificial table are clean of chips and burrs then install the sacrificial table making sure that it is flush against the B-table. Install the two M4 x 10 fasteners and tighten till snug. Do not overtighten. A good gauge of an appropriate level of tightness is to tighten the screw with a 3mm hex wrench only to the point that the wrench starts to flex.

Use the provided fasteners or any other M4 fastener to attach work pieces to the table directly, with dog clamps, or with a custom fixture. Make sure that your stock is in the same location relative to the Pocket NC's center of rotation (B-table offset) as it is in your model. The edge finding tutorial, found on our website, may be helpful for accurately locating the part.

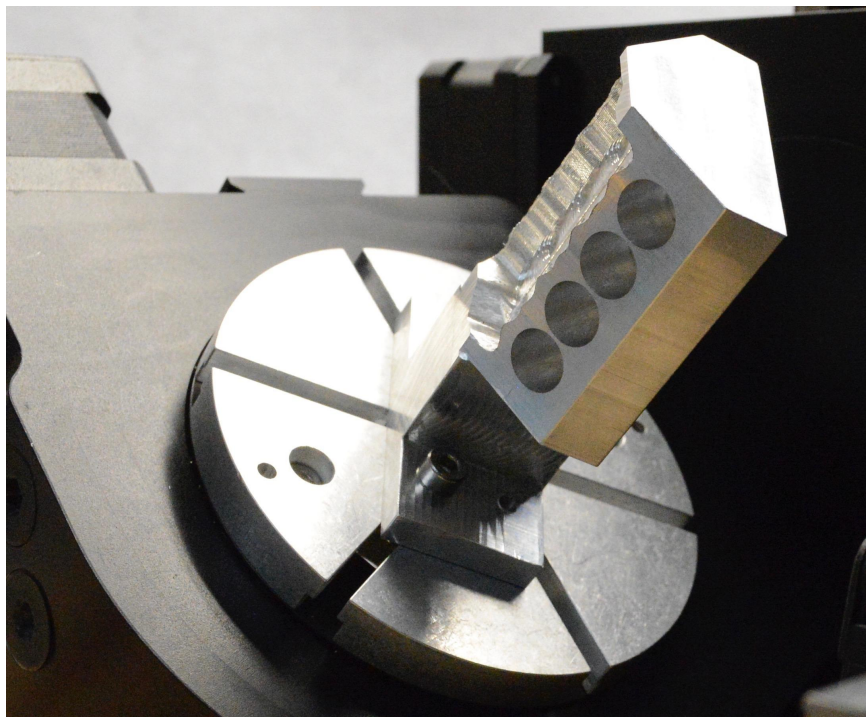



## Chapter 4: G and M Codes

See the following tables for the G and M Codes supported by Pocket NC.

For more information on G and M codes, go to these links:

<http://linuxcnc.org/docs/html/gcode.html> and <http://linuxcnc.org/docs/html/gcode/m-code.html>.

G code	Description	G code	Description
G00	Rapid positioning	G56	Work coordinate offset 3
G01	Linear interpolation	G57	Work coordinate offset 4
G02	Circular interpolation clockwise (CW)	G58	Work coordinate offset 5
G03	Circular interpolation counterclockwise (CW)	G59	Work coordinate offset 6
G04	Dwell - as a separate block only	G59.1	Work coordinate offset 7
G05	Cubic Spline	G59.2	Work coordinate offset 8
G05.1	Quadratic Spline	G59.3	Work coordinate offset 9
G05.2	NURBS Block	G61	Exact Path Mode
G05.3	NURBS Block	G61.1	Exact Stop Mode
G10 L1	Set Tool Table	G64	Path Bending
G10 L2	Set Coordinate System	G73	Drilling Cycle with Chip Breaking
G10 L10	Set Tool Table	G80	Fixed cycle cancel
G10 L11	Set Tool Table	G81	Drilling cycle
G10 L20	Set Coordinate System	G82	Spot-drilling cycle
G17	XY-plane designation	G83	Peck-drilling cycle (deep hole drilling cycle)
G18	ZX-plane designation	G85	Boring cycle, Feed Out
G19	YZ-plane designation	G86	Boring cycle, Spindle Stop, Rapid Move Out
G17.1	UV-plane designation	G89	Boring cycle, Dwell, Feed Out
G18.1	WU-plane designation	G90	Absolute dimensioning mode
G19.1	VW-plane designation	G91	Incremental dimensioning mode
G20	Imperial units of input	G90.1	Absolute Arc Distance Mode
G21	Metric units of input	G91.1	Incremental Arc Distance Mode



G28, G28.1	Go to Predefined Position	G92	Coordinate System Offset
G30, G30.1	Go to Predefined Position	G92.1	Reset Coordinate System Offsets
G40	Cutter radius compensation cancel	G92.2	Reset Coordinate System Offsets
G41	Cutter radius compensation - left	G92.3	Restore Axis Offsets
G42	Cutter radius compensation - right	G93	Feed Rate Mode, Inverse Time Mode
G43	Tool length offset	G94	Feed Rate Mode, Units Per Minute Mode
G43.1	Dynamic Tool Length Offset	G95	Feed Rate Mode, Units per Revolution Mode
G49	Cancel Tool Length Compensation	G96	Spindle Control Mode
G53	Machine coordinate system	G97	Spindle Control Mode
G54	Work coordinate offset 1	G98	Return to initial level in a fixed cycle
G55	Work coordinate offset 2	G99	Return to R-level in fixed cycle

M Code	Description
M00	Program Pause
M01	Program Pause
M02	End of program(usually with reset, no rewind)
M03	Spindle rotation normal (CW for R/H tools)
M04	Spindle rotation reverse (CCW for R/H tools)
M05	Spindle stop
M06	Manual Tool Change
M30	Program end (always with reset and rewind)
M48	Feedrate override cancel OFF (deactivated)
M49	Feedrate override cancel ON (activated)
M50	Feed Override Control
M51	Spindle Speed Override Control
M52	Adaptive Feed Control
M53	Feed Stop Control
M60	Automatic pallet change (APC)
M61	Set Current Tool Number



## Chapter 5: Maintenance, Storage, and Transport

### Chapter 5.1 Maintenance

All of the electronics, motors and bearings on the Pocket NC are fairly well covered so debris on top of them should not affect functionality. Although, it is recommended that users regularly clean the machine using a vacuum cleaner with an extension and/or soft brush attachment to get into the crevices.

Wipe the machine with a soft, lint-free cloth to remove fine debris and dust. Isopropyl alcohol is recommended for removing oil or grease.

There are no parts that need oiling or greasing. Applying oil or grease to the lead screws or other components will cause debris to stick to them and may result in impaired function and increased wear.

### Chapter 5.2: Storage

If you will be storing your Pocket NC for an extended period of time or corrosion is likely for other reasons, a small amount of light oil may be applied to the lead screws and other steel components in order to prevent rust.

Store the Pocket NC in a dry location, protect the wires from excessive UV exposure and avoid operating the machine immediately after large temperature changes that could cause condensation build up inside the machine. If possible store the Pocket NC in a watertight container or a plastic bag and use desiccant to prevent moisture buildup.

### Chapter 5.3: Transport

If you will be transporting your Pocket NC, especially if it is shipped as freight, install the shipping bolts to help prevent damage to the axes in case of an impact during shipment. If possible, retain and reuse the original materials used to ship your Pocket NC. They have been carefully designed to protect the machine.



## Chapter 6: Troubleshooting Common Problems

Our goal at Pocket NC is to produce an excellent product at an affordable price so that people can turn their ideas into reality. We hope that using our product is a straightforward process and the machine functions perfectly. But, we know that things don't always go perfectly. Hopefully this troubleshooting guide can help you resolve some of the problems that come up.

If your problem is not covered here, or if you need some more information, please [contact us](#).

For instructions on how to run the machine, set-up parts for machining, measure tool offsets and other operation instruction see our [tutorials](#).





## Chapter 6.1: Common Problems

Problem	Possible Solutions
<p>I can't connect to my Pocket NC or the user interface is not loading correctly on my computer.</p>	<ol style="list-style-type: none"> <li>1. Check that the Pocket NC is plugged in and is powered on. The red LED on the E-stop button will light up when the machine is on. The user interface is ready to boot when the red LED starts blinking. It can take up to 2 and half minutes to fully boot the Pocket NC.</li> <li>2. The computer must be connected to the mini-USB port on the mill not the standard USB port.</li> <li>3. The mini USB may not be fully plugged into the machine. The pocket is deep so the plastic around the plug may have to be trimmed to fit.</li> <li>4. The machine may not be fully booted. Wait 1 minute after turning on the machine before trying to connect.</li> <li>5. The user interface may not load properly in every browser. Try using Chrome, Firefox, or Safari</li> <li>6. Try rebooting the machine: power off the machine, unplug all the cords, wait about a minute for the capacitors to drain then plug it back in and restart.</li> <li>7. You may need a different driver. Try downloading a new driver from the Beagleboard <a href="#">website</a>.</li> <li>8. Contact the <a href="#">Pocket NC help desk</a> or post on the <a href="#">Pocket NC forum</a> for help.</li> </ol>
<p>The Pocket NC is unresponsive, nothing happens when I tell the Pocket NC to move.</p>	<ol style="list-style-type: none"> <li>1. Check that the Pocket NC is plugged in and that the power switch is on. The Pocket NC's electronics can run off computer power, but the motors can't.</li> <li>2. Make sure that the Pocket NC is not in E-stop mode. When the machine is in E-stop the red button on the machine will blink and the buttons in the upper right</li> </ol>



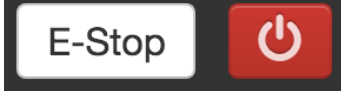

	<p>corner of the user interface will be gray/white.</p>  <p>Push the E-stop button to enable the motors.</p>  <ol style="list-style-type: none"> <li>3. Check that the computer is still connected to the Pocket NC with the USB cord.</li> <li>4. Try rebooting the machine: power off the machine, unplug all the cords, wait about a minute for the capacitors to drain then plug it back in and restart.</li> <li>5. Contact the <a href="#">Pocket NC help desk</a> or post of the <a href="#">Pocket NC forum</a> for help.</li> </ol>
<p>One of the axes on my Pocket NC is not working</p>	<ol style="list-style-type: none"> <li>1. Try rebooting the machine: power off the machine, unplug all the cords, wait about a minute for the capacitors to drain then plug it back in and restart.</li> <li>2. Check the electrical connections for that axis. Look for damage and debris.</li> <li>3. Contact the <a href="#">Pocket NC help desk</a> or post of the <a href="#">Pocket NC forum</a> for help.</li> </ol>
<p>The Pocket NC motors are noisy when the machine is running</p>	<p>Particularly at low feed rates, the stepper motors can produce quite a bit of noise. This is due to the electrical interference in the driver circuit.</p> <p>Increasing the feed rate usually decreases the sound.</p>
<p>The Pocket NC is not cutting in the location that I expected.</p>	<ol style="list-style-type: none"> <li>1. Make sure that the origin for your toolpaths is the B table offset/machine origin point of the Pocket NC. This is a point in space about 0.839 inches above the center of the B table.</li> <li>2. Check if the coordinate system of your machining</li> </ol>





	<p>setup in CAM is set up so that the positive Z axis points at the spindle of the Pocket NC, the positive X axis points at the A table, and the positive Y axis points straight up from the B table.</p> <ol style="list-style-type: none"><li>3. Check if the toolpath origin is also the B table offset/machine origin point and that the toolpath coordinate system is appropriate. Remember that the Z axis is always the Pocket NC spindle.</li><li>4. Make sure that your stock is located in the same place on your machine as it was relative to the origin point in your CAM program.</li></ol>
I can't find/load my G-code file	<ol style="list-style-type: none"><li>1. Check if the selection set for the file type includes your file extension (file type) for example you can't find machining files with a .nc extension if the selection set is looking for only .ngc files</li><li>2. The file must be a text file that the Pocket NC is capable of reading. Generally these will have a extension like .ngc, .nc, or .cnc but any machinable file should work.</li></ol>



## Chapter 6.2: Machining/Performance Issues

Problem	Explanation	Possible Solution/Things to Try
<p>My tool chatters during the cut.</p>	<p>Vibration causes the cutter to not cut smoothly. This vibration is due to the natural frequency of the tool/spindle.</p>	<ol style="list-style-type: none"> <li>1. The feed and speed, and/or step-down and step-over need to be adjusted. See the <a href="#">feeds and speeds tutorial</a> for more information.</li> <li>2. Turn the spindle speed up.</li> <li>3. Adjust the feedrate, usually moving slower will be smoother, but this is not always the case</li> <li>4. Increase the step-down, taking a deeper cut into the material</li> <li>5. Increase or decrease the step-over, the width of the cut. Typically the ideal step-over is about 60% of tool diameter.</li> </ol>
<p>Spindle sounds like it is slowing down during the cut.</p>	<p>The spindle power is insufficient for the amount of material being removed.</p>	<ol style="list-style-type: none"> <li>1. Decrease the feed rate in 5% steps until the spindle stops bogging down</li> <li>2. Decrease the step-down and step over in your toolpaths.</li> <li>3. Switch to a tool with more cutting flutes.</li> </ol>
<p>The Pocket NC is not cutting in the location that I expected.</p>		<ol style="list-style-type: none"> <li>1. Make sure that the origin for your toolpaths is the B table offset/machine origin point of the Pocket NC.</li> </ol>



	<p>The stock may not be located in the same position relative to the origin point that it was in the CAM software used to create the toolpaths</p>	<p>This is a point in space about 0.839 inches above the center of B table.</p> <ol style="list-style-type: none"> <li>2. Check if the coordinate system of your machining setup in CAM is set up so that the positive Z axis points at the spindle of the Pocket NC, the positive X axis points at the A table, and the positive Y axis points straight up from the B table.</li> <li>3. Check if the toolpath origin is also the B table offset/machine origin point and that the toolpath coordinate system is appropriate. Remember that the Z axis is always the Pocket NC spindle.</li> <li>4. Make sure that your stock is located in the same place on your machine as it was relative to the origin point in your CAM program.</li> </ol>
<p>The drive/lead screws squeak.</p>	<p>The end of the lead screw is touching the frame of the machine when it turns.</p>	<ol style="list-style-type: none"> <li>1. Make sure that the screw and the hole are free of debris.</li> <li>2. If the noise it minor is is best to let it wear into position. The noise should decrease with time             <ul style="list-style-type: none"> <li>- Use a very small amount of general purpose synthetic grease to lubricate the tip of the screw.</li> <li>- Do not grease the whole</li> </ul> </li> </ol>



		<p>screw.</p> <ul style="list-style-type: none"><li>- Do not put grease where it will contact the anti-backlash nuts.</li><li>- Grease will collect debris and may cause increased wear on your machine.</li></ul>
--	--	--



## Chapter 6.3: Error Codes

Error Code/Message	Explanation	Possible Solutions
<p>Near Line XX Linear Move Exceeds Joint X's Positive/Negative Limit</p>	<p>This error means that the toolpath/G code is telling the machine to go past one its travel limits</p> <p>Joint 0 = X axis            Joint 1 = Y axis            Joint 2 = Z axis            Joint 3 = A axis            Joint 4 = B axis</p> <p>This error is often caused by a tool length offset being set incorrectly or by a part that is outside the Pocket NC's work envelope.</p> <p>The move that is causing the error is located on or near the line of the program indicated</p>	<ol style="list-style-type: none"> <li>1. If the error is on joint 2 (Z axis), check if your tool length offset is set correctly. See the <a href="#">"Tool Length Offset" tutorial</a> for more information.</li> <li>2. If the error is for exceeding the negative limit of joint 2 and the tool length offset is correct, increase the tool stickout or switch to a longer tool holder.</li> <li>3. If the error is for exceeding the positive limit of joint 2 and the tool length offset is correct, decrease the tool stickout or switch to a shorter tool holder.</li> <li>4. Check if your toolpath is asking the machine to exceed its limits of travel. Open your code in a text editing program and use the search bar (CTRL + F) to search for any values that are greater than the limits of travel for the Pocket NC mill.             <ol style="list-style-type: none"> <li>a. The X limits are -2.00 to 2.55 inches</li> </ol> </li> </ol>



		<ul style="list-style-type: none"> <li>b. The Y limits are -2.4 to 2.6 inches</li> <li>c. The Z limits are -3.45 to 0.10 inches*</li> <li>d. The A limits are -25 to 135 degrees</li> <li>e. The B limits are -9999 to 9999 degrees</li> </ul> <p>*you have to add the tool length offset to the Z axis value</p> <ul style="list-style-type: none"> <li>5. Adjust the location of the part/stock so that it is within the Pocket NC's work envelope</li> <li>6. Decrease the retract height on the toolpaths if the part is close to the limits of the Pocket NC's travel.</li> <li>7. Oversized parts may be able to be fixtured and cut one side at a time instead of all in one program.</li> </ul>
<p>14 Unexpected Real Time Delay on RT Thread 1</p>	<p>This error means that there has been a delay in the Beaglebones processor.</p>	<ul style="list-style-type: none"> <li>1. This error can be caused by a temporarily dropped connection between the computer and the Pocket NC mill or by a program that is so large and complicated that the Beaglebone's processor cannot keep up.</li> <li>2. Check that the</li> </ul>



		<p>connection between the computer and the machine is good.</p> <p>3. Try slowing down the feed rate or reducing the file size of the G code file by breaking it into more than 1 program or by loosening the tolerances in the toolpath and reposting it.</p>
--	--	--